

e2v

EV10AQ190-EB Evaluation Board

.....
User Guide

Introduction

-
- 1.1 Scope**
- The EV10AQ190-EB Evaluation Kit is designed to facilitate the evaluation and characterization of the EV10AQ190 Quad 10-bit 1.25 Gsps ADC in AC coupled mode.
- The EV10AQ190-EB Evaluation Kit includes:
- The Quad 10-bit 1.25 Gsps ADC Evaluation Board including EV10AQ190 ADC and Atmel ATMEGA128 AVR soldered
 - A cable for connection to the RS-232 port
 - Software tools necessary to use the SPI
- The user guide uses the EV10AQ190-EB Evaluation Kit as an evaluation and demonstration platform and provides guidelines for its proper use.
-
- 1.2 Description**
- The EV10AQ190-EB Evaluation Board is very straightforward as it implements e2v EV10AQ190 Quad 10-bit 1.25 Gsps ADC device, Atmel ATMEGA128 AVR, SMA connectors for the sampling clock, analog inputs and reset inputs accesses and 2.54 mm pitch connectors compatible with high-speed acquisition system probes.
- Thanks to its user-friendly interface, the EV10AQ190-EB Kit enables to test all the functions of the EV10AQ190 Quad 10-bit 1.25 Gsps ADC using the SPI connected to a PC.
- To achieve optimal performance, the EV10AQ190-EB Evaluation Board was designed in a 6-metal-layer board using FR4 HTG epoxy dielectric material (200 μm , ISOLA IS410 featuring a resin content of 45%). The board implements the following devices:
- The Quad 10-bit 1.25 Gsps ADC Evaluation Board with the EV10AQ190 ADC soldered
 - SMA connectors for CLK, CLKN, AAI, AAIN, BAI, BAIN, CAI, CAIN, DAI, DAIN, SYNCN, SYNCP, CAL, CALN signals
 - 2.54 mm pitch connectors for the digital outputs, compatible with high-speed acquisition system probes
 - Banana jacks for the power supply accesses, the die junction temperature monitoring functions, reference resistor, analog input common mode voltage (2 mm)
 - An RS-232 connector for PC interface

The board dimensions are 170 mm x 185 mm. The board comes fully assembled and tested, with the EV10AQ190 installed.

Figure 1-1. EV10AQ190-EB Evaluation Board Simplified Schematic

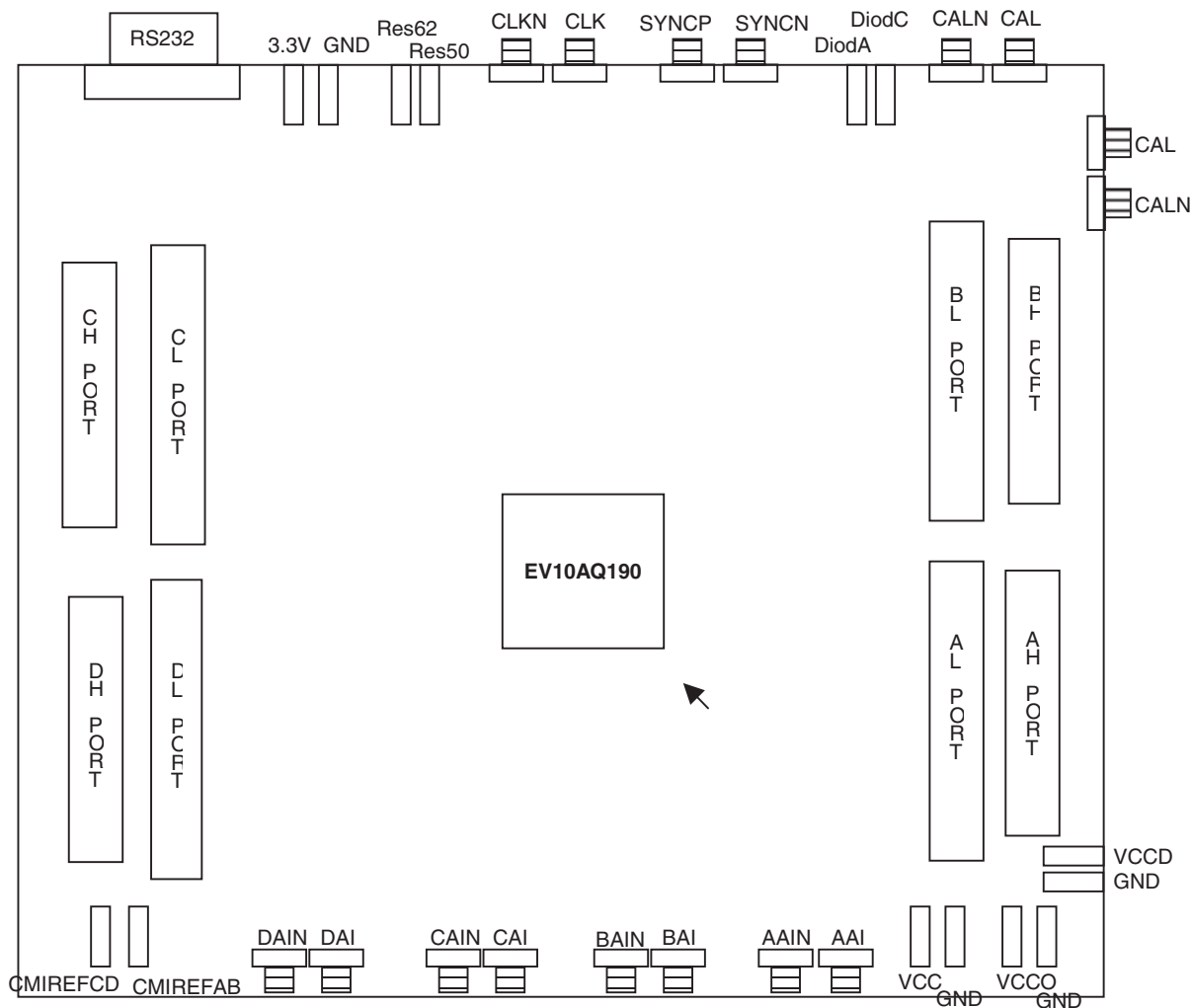

As shown in Figure 1-1, different power supplies are required:

- $V_{CC} = 3.3V$ analog positive power supply (includes the SPI pads)
- $V_{CCD} = 1.8V$ digital positive power supply
- $V_{CCO} = 1.8V$ output power supply
- 3.3V digital interface primary power supply for the microcontroller

Hardware Description

2.1 Board Structure In order to achieve optimum full-speed operation of the EV10AQ190 Quad 10-bit 1.25 Gbps ADC, a multilayer board structure was retained for the evaluation board. Six copper layers are used, dedicated to the signal traces, ground planes and power supply planes.

The board is made in FR4 HTG epoxy dielectric material (ISOLA IS410). Table 2-1 gives a detailed description of the board's structure.

Table 2-1. Board Layer Thickness Profile

Layer	Characteristics
Layer 1 Copper layer	Copper thickness = 40 μm (with NiAu finish) AC signals traces = 50 Ω microstrip lines DC signals traces
FR4 HTG/dielectric layer	Layer thickness = 200 μm
Layer 2 Copper layer	Copper thickness = 18 μm Upper ground plane = reference plane
FR4 HTG/dielectric layer	Layer thickness = 349 μm
Layer 3 Copper layer	Copper thickness = 18 μm Power plane = V_{CC}
FR4 HTG/dielectric layer	Layer thickness = 350 μm
Layer 4 Copper layer	Copper thickness = 18 μm Power planes = V_{CCD} , V_{CCO} and 3V3
FR4 HTG/dielectric layer	Layer thickness = 350 μm
Layer 5 Copper layer	Copper thickness = 18 μm Power planes = reference plane (identical to layer 3)
FR4 HTG/dielectric layer	Layer thickness = 200 μm
Layer 6 Copper layer	Copper thickness = 40 μm (with NiAu finish) AC signals traces = 50 Ω microstrip lines DC signals traces

The board is 1.6 mm thick. The clock, analog inputs, resets, digital data output signals and ADC functions occupy the top metal layer while the SPI signals and circuitry occupy the bottom layer.

The ground planes occupy layer 2 and 5. Layer 3 and 4 are dedicated to the power supplies.

2.2 Analog Inputs/Clock Input

The differential clock and analog inputs are provided by SMA connectors (reference: VITELEC 142-0701-8511). Both pairs are AC coupled using 10 nF capacitors.

Special care was taken for the routing of the analog and clock input signals for optimum performance in the high-frequency domain:

- 50Ω lines matched to ± 0.1 mm (in length) between XAI and XAIN (X = A, B, C or D) or CLK and CLKN
- 909 μm pitch between the differential traces
- 1270 μm between two differential pairs
- 361 μm line width
- 40 μm thickness
- 850 μm diameter hole in the ground layer below the XAI and XAIN or CLK and CLKN ball footprints

Figure 2-1. Board Layout for the Differential Analog and Clock Inputs

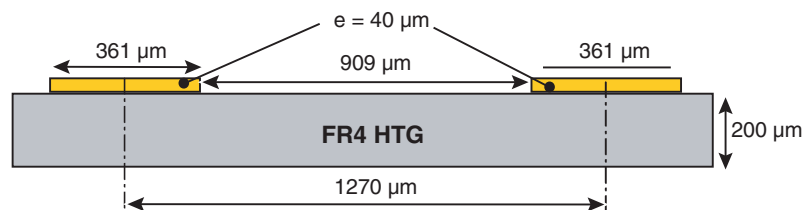

Note: The analog inputs and clock inputs are AC coupled with 10 nF very close to the SMA connectors.

2.3 Digital Output

The digital output lines were designed with the following recommendations:

- 50Ω lines matched to ± 2.5 mm (in length) between signal of the same differential pair
- ± 1 mm line length difference between signals of two differential pairs
- 635 μm pitch between the differential traces
- 650 μm between two differential pairs
- 310 μm line width
- 40 μm thickness

Figure 2-2. Board Layout for the Differential Digital Outputs

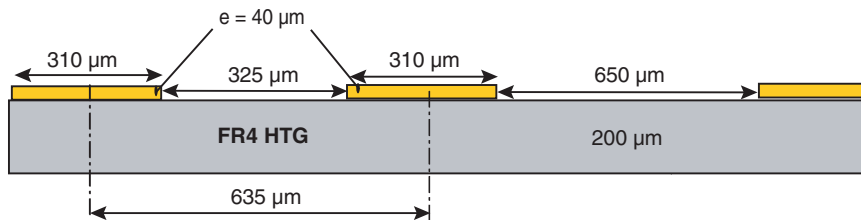

The digital outputs are compatible with LVDS standard. They are on-board 100Ω differentially terminated as described in Figure 2-3.

Figure 2-3. Differential Digital Outputs Implementation

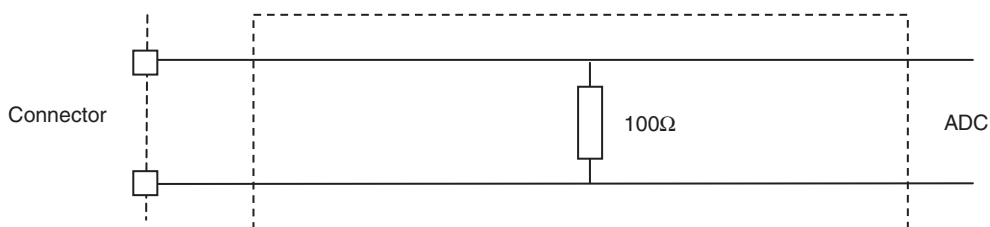

Double row 2.54 mm pitch connectors are used for the digital output data. The upper row is connected to the signal while the lower row is connected to ground, as illustrated in Figure 2-4.

Figure 2-4. Differential Digital Outputs 2.54 mm Pitch Connector (X = A, B, C or D)

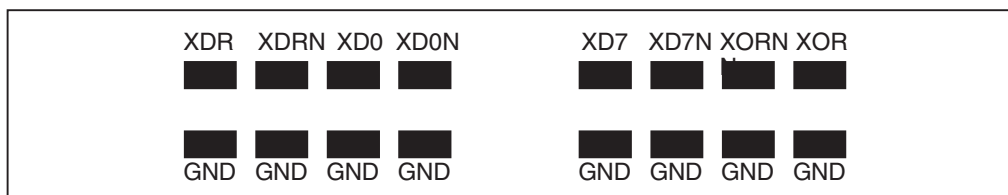

2.4 Reset Inputs

Two hardware reset signals are provided:

- SYNC, SYNCN corresponds to the reset of the output clock of the ADC (analog reset).
- RSTN corresponds to the reset of the SPI (makes the SPI registers go to their default value).

The differential reset inputs SYNC, SYNCN are provided by SMA connectors (reference: VITELEC 142-0701-8511). The signals are AC coupled using 10 nF capacitors and pulled up and down via 200Ω resistors. A variable resistor of 500Ω is implemented on SYNC: by adjusting this resistor value one can activate and deactivate easily the reset signal.

- 50Ω lines matched to ±0.1 mm (in length) between SYNCP and SYNCN
- 909 μm pitch between the differential traces
- 1270 μm between two differential pairs
- 361 μm line width
- 40 μm thickness

Figure 2-5. Board Layout for the SYNC Signal

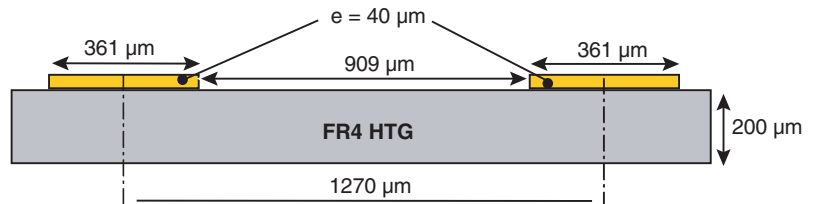
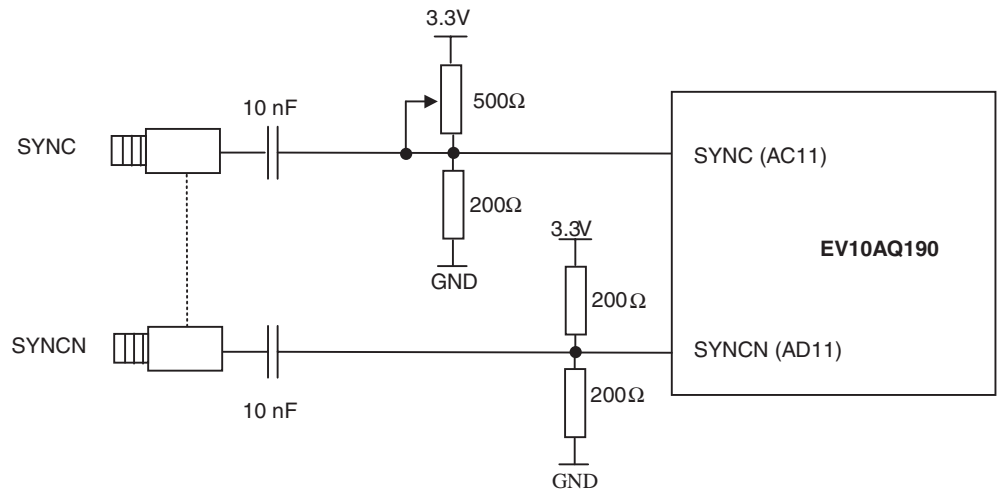
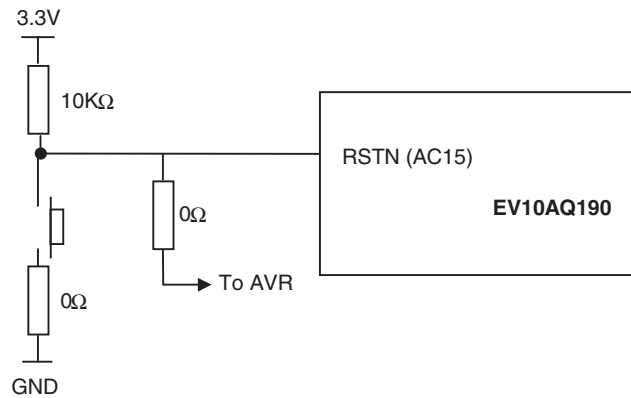

Figure 2-6. SYNC, SYNCN Inputs Implementation



A push button is provided for the RSTN reset, as described in Figure 2-7 on page 9. This reset can also be generated through the AVR (via the User Interface).

Figure 2-7. RSTN Input Implementation

2.5 Power Supplies

Layers 3 and 4 are dedicated to power supply planes (V_{CC} , V_{CCD} , V_{CCO} and 3.3V).

The supply traces are low impedance and are surrounded by two ground planes (layer 2 and 5).

Each incoming power supply is bypassed at the banana jack by a 1 μ F Tantalum capacitor in parallel with a 100 nF chip capacitor.

Each power supply is decoupled as close as possible to the EV10AQ190 device by 10 nF in parallel with 100 pF surface mount chip capacitors.

Note: The decoupling capacitors are superimposed with the 100 pF capacitor mounted first.

Operating Characteristics

3.1 Introduction

This section describes a typical configuration for operating the evaluation board of the EV10AQ190 Quad 10-bit 1.25 Gsps ADC.

The analog input signals and the sampling clock signal should be accessed in a differential fashion. Band pass filters should also be used to optimize the performance of the ADC both on the analog input and on the clock.

It is necessary to use a very low jitter source for the clock signal (recommended maximum jitter = 50 ps).

Note: The analog inputs and clock are AC coupled on the board.

3.2 Operating Procedure

1. Install the SPI software as described in section 4 *Software Tools*.
2. Connect the power supplies and ground accesses through the dedicated banana jacks. $V_{CC} = 3.3V$, $V_{CCD} = 1.8V$, $V_{CCO} = 1.8V$ and $3.3V$.
3. Connect the clock input signals. Use a very low-phase noise high-frequency generator as well as a band pass filter to optimize the clock performance. The clock input level is typically 3 dBm and should not exceed 10 dBm (into 50Ω). The clock frequency should be set to 2.5 GHz (corresponding to 1.25 Gsps sampling in 4-channel mode or 2.5 Gsps sampling in 2-channel mode or 5 Gsps sampling in 1-channel mode).
4. Connect the analog input signals (the board has been designed to allow only AC coupled analog inputs). Use a low-phase noise high-frequency generator as well as a band pass filter to optimize the analog input performance. The analog input full scale is 500 mV peak-to-peak around zero (analog input providing the Input common mode). It is recommended to use the ADC with an input signal of -1 dBFS max (to avoid saturation of the ADC).
5. Connect the high-speed acquisition system probes to the output connectors. The digital data are differentially terminated on-board (100Ω) however, they can be probed either in differential or in single-ended mode.
6. Connect the PC's RS-232 connector to the evaluation board's serial interface.
7. Switch on the ADC power supplies (recommended power up sequence: simultaneous or in the following order: $V_{CC} = 3.3V$, $V_{CCD} = 1.8V$, $V_{CCO} = 1.8V$ and $3.3V$).
8. Turn on the RF clock generator.
9. Turn on the RF signal generator.

10. Perform an analog reset (SYNC potentiometer) on the device.
11. Launch Quad-10bit.exe software.

The EV10AQ190-EB evaluation board is now ready for operation.

3.3 Electrical Characteristics

For more information, please refer to the device datasheet.

Table 3-1. Recommended Conditions of Use

Parameter	Symbol	Comments	Recommended	Unit
Positive supply voltage	V_{CC}	Includes SPI pads	3.3	V
Positive digital supply voltage	V_{CCD}	SPI core	1.8	V
Positive output supply voltage	V_{CCO}	Output buffers	1.8	V
Differential analog input voltage (Full Scale)	V_{IN}, V_{INN}		± 250	mV
	$V_{IN} - V_{INN}$		500	mVpp
Digital CMOS input	V_D	V_{IL} V_{IH}	0 V_{CC}	V
Clock input power level	$P_{CLK} P_{CLKN}$		0	dBm
Clock frequency	F_{CLK}	For operation at 1.25 Gsps, 2.5 Gsps or 5 Gsps in 4-channel, 2-channel or 1-channel mode respectively	2.5	GHz
Storage temperature	T_{stg}		-55 to 150	°C

Typical conditions:

- $V_{CC} = 3.3V, V_{CCD} = 1.8V, V_{CCO} = 1.8V$
- $V_{IN} - V_{INN} = 500$ mVpp full scale differential input, digital outputs LVDS (100Ω)
- T_{amb} (typical) = 25°C unless otherwise specified

Table 3-2. Electrical Characteristics

Parameter	Symbol	Test Level	Min	Typ	Max	Unit
Resolution				10		Bit
Power Requirements						
Power supply voltage						
Analog and SPI pads	V_{CC}		3.15	3.3	3.45	V
Digital	V_{CCD}		1.7	1.8	1.9	V
Output	V_{CCO}		1.7	1.8	1.9	V
Power supply current						
Analog and SPI pads	I_{CC}			1.6		A
Digital	I_{CCD}			202		mA
Output	I_{CCO}			3		mA
Power supply current (Partial standby mode AB)						
Analog and SPI pads	I_{CC}			884		mA
Digital	I_{CCD}			114		mA
Output	I_{CCO}			3		mA
Power supply current (Partial standby mode CD)						
Analog and SPI pads	I_{CC}			899		mA
Digital	I_{CCD}			109		mA
Output	I_{CCO}			3		mA
Power supply current (full standby mode)						
Analog and SPI pads	I_{CC}			188		mA
Digital	I_{CCD}			23		mA
Output	I_{CCO}			3		mA
Power dissipation						
Default mode				5.64		W
Partial standby mode (AB)	P_D			3.12		W
Partial standby mode (CD)				3.16		W
Full standby mode				0.66		

Software Tools

4.1 Overview The Quad 10-bit 1.25 Gbps ADC Evaluation user interface software is a Visual C++[®] compiled graphical interface that does not require a licence to run on a Windows[®] NT[®] and Windows[®] 2000/98/XP[®] PC.

The software uses intuitive push-buttons and pop-up menus to write data from the hardware.

4.2 Configuration The advised configuration for Windows[®] 98 is:

- PC with Intel[®] Pentium[®] Microprocessor of over 100 MHz
- Memory of at least 24 Mo

For other versions of Windows[®] OS, use the recommended configuration from Microsoft.

Note: Two COM ports are necessary to use two boards simultaneously.

- ### 4.3 Getting Started
1. Install the ADC Quad 10-bit application on your computer by launching the Setup_Quad-10bit.exe installer (please refer to the latest version available).

Figure 4-1. Install Window

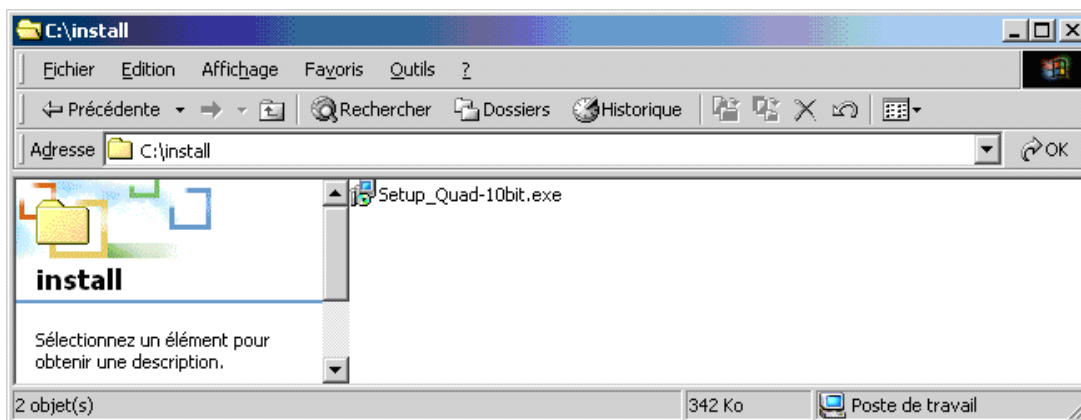

The screen shown in Figure 4-2 is displayed.

Figure 4-2. QUAD 10-bit 1.25 Gbps Application Setup wizard Window

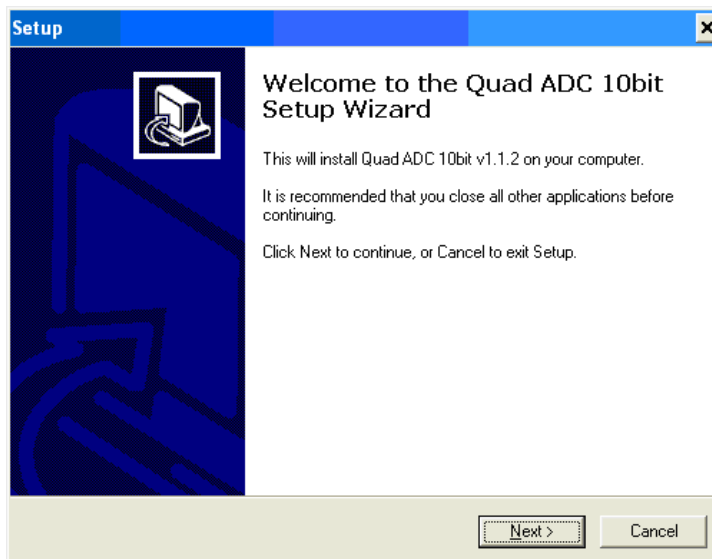

2. Select Destination Directory

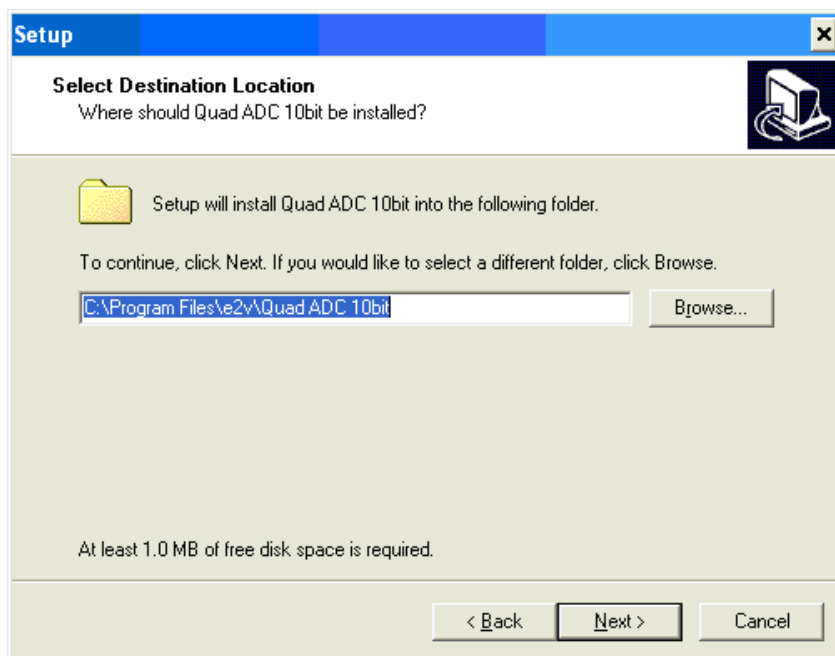
Figure 4-3. QUAD 10-bit 1.25 Gsps *Select Destination Directory* Window

3. Select Start Menu Folder

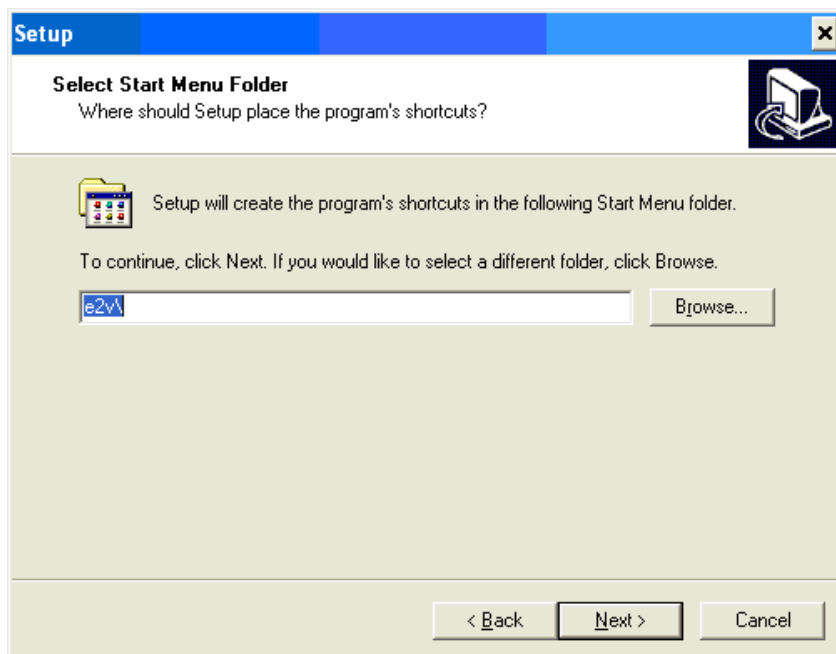
Figure 4-4. QUAD 10-bit 1.25 Gsps *Select Start Menu* Window

4. Ready to install

Figure 4-5. QUAD 10-bit 1.25 Gps *Ready To Install* Window

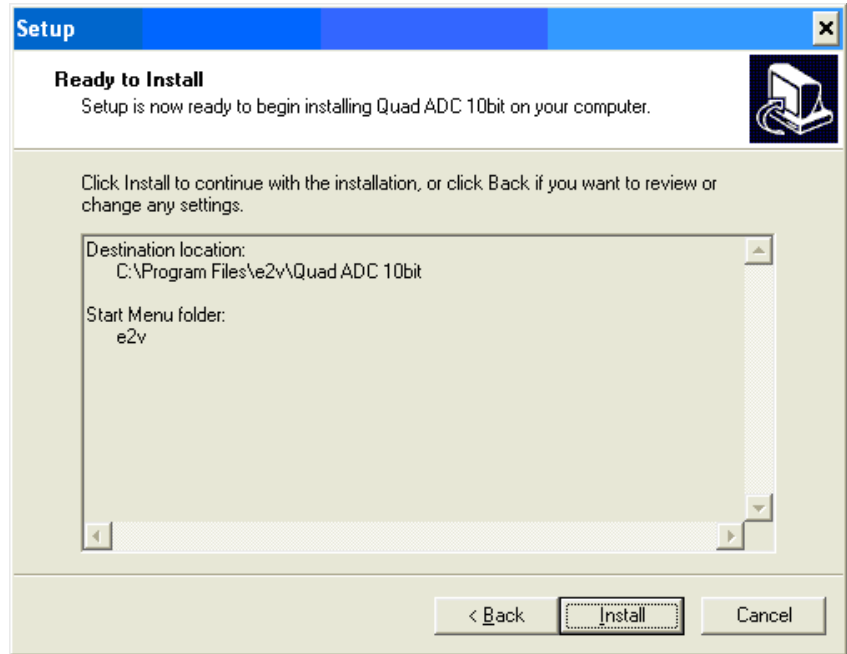

If you agree with the install configuration, press Install button.

Figure 4-6. QUAD 10-bit 1.25 Gps Application Setup *Install* Push Button

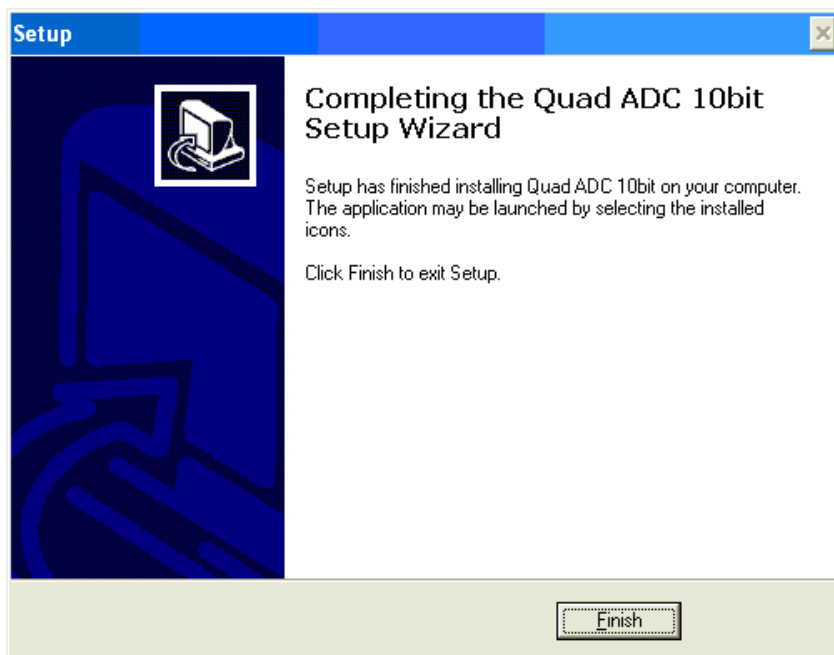

The installation of the software is now complete.

Figure 4-7. QUAD 10-bit 1.25 Gbps Completing Setup Wizard Window

After the installation, you can launch the interface with the following file:

C:\Program Files\e2v\QUAD_10bit\Quad ADC 10bit.exe

The window shown in Figure 4-8 will be displayed.

Figure 4-8. QUAD 10-bit 1.25 Gbps User Interface Window

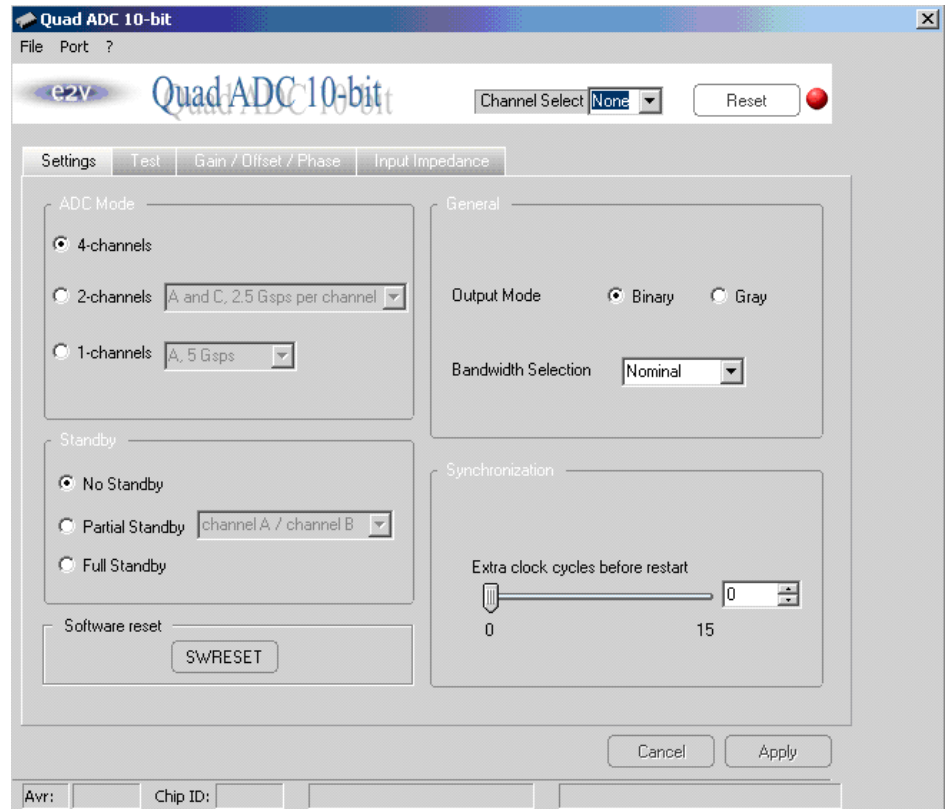

- Notes:
1. If the QUAD 10-bit 1.25 Gbps application board is not connected or not powered, a red LED appears on the right of the reset button and the application is grayed out.
 2. Check your connection and restart the application.
 3. If the serial interface is not active the LED appears in orange and the application is grayed out.

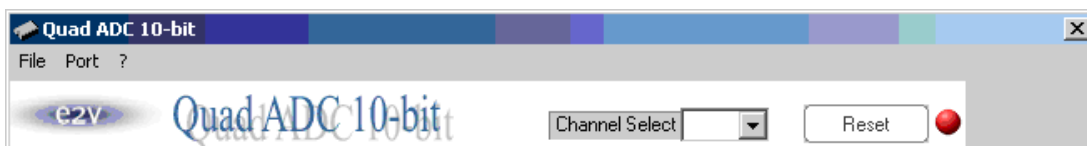
Figure 4-9. QUAD 10-bit 1.25 Gsps User Interface Window

Switch ON power supplies and launch the Quad ADC 10bit.exe, the application should become available and the LED turns to green.

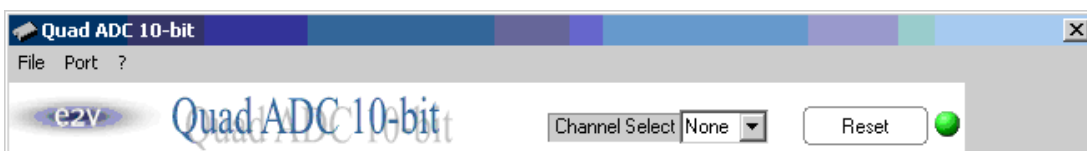
Figure 4-10. QUAD 10-bit 1.25 Gsps User Interface Window

4.4 Troubleshooting

1. check that you own rights to write in the directory.
2. check for the available disk space.
3. check that at least one RS-232 serial port is free and properly configured.
4. check that the serial port and DB9 connector are properly connected.
5. check that all supplies are properly powered on.

The serial port configuration should be as follows:

- Bit rate: 19200
- Data coding: 8 bits
- 1 start bit, 1 stop bit
- No parity check

Figure 4-11. QUAD 10-bit 1.25 Gsps User Interface Hardware Implementation

1. Use an RS-232 port to send data to the ADC.
2. Connect the crossed DB9 (F/F) cable between your PC and your evaluation board as illustrated in Figure 4.12.

Figure 4-12. Crossed Cable

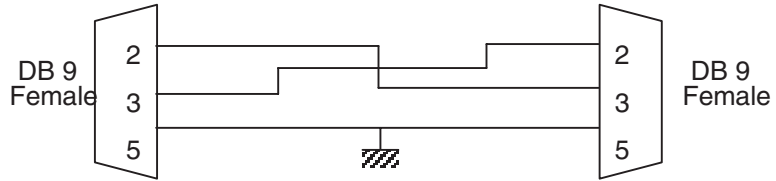

4.5 Installation Software

At startup, the application automatically checks all RS232 ports available on the computer and tries to find the evaluation board connected to the RS232 port.

Figure 4-13. QUAD 10-bit 1.25 Gbps User Interface Port Menu

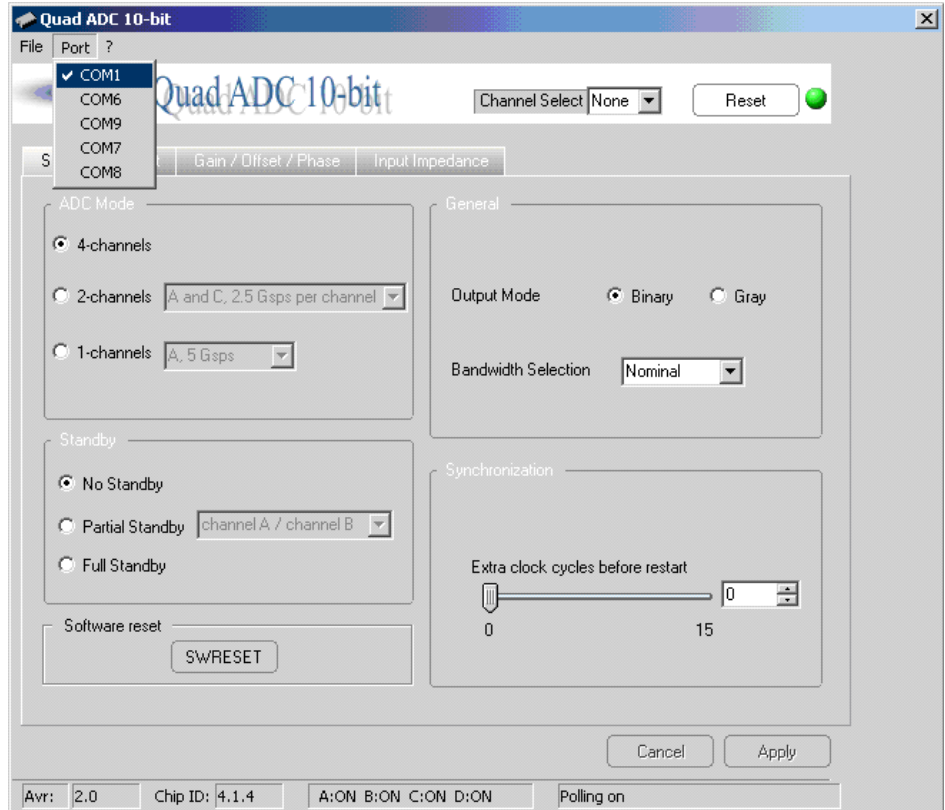

The *Port* menu shows all available ports on your computer. The port currently used has a check mark on its left. By clicking another port item the application will try to connect to an evaluation board via the selected port. If a board is successfully detected on the new port, the LED is green and the new port gets the check mark. If the application is not able to find a board on this port, an error message is displayed.

4.6 Operating Modes

The Quad ADC software included with the evaluation board provides a graphical user interface to configure the ADC.

Push buttons, popup menus and capture windows allows easy:

1. Settings.
2. Test mode.
3. Gain/Offset/Phase adjustments.

With Setting and Test mode windows always click on *Apply* button to validate any command.



Clicking the *Cancel* button will restore last settings sent with *Apply* button.

With Gain/Offset/Phase and INL windows always click on *Write* then *Send* buttons to validate any command.

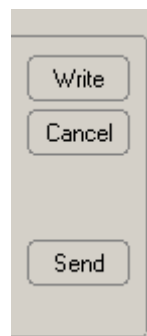

Reset button allows reconfiguring ADC to Default Mode.

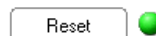

or

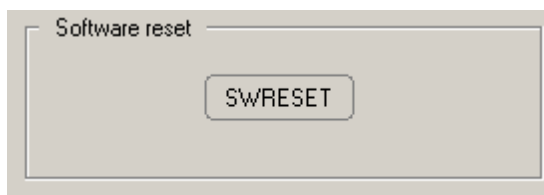

4.6.1 Settings

Figure 4-14. Settings

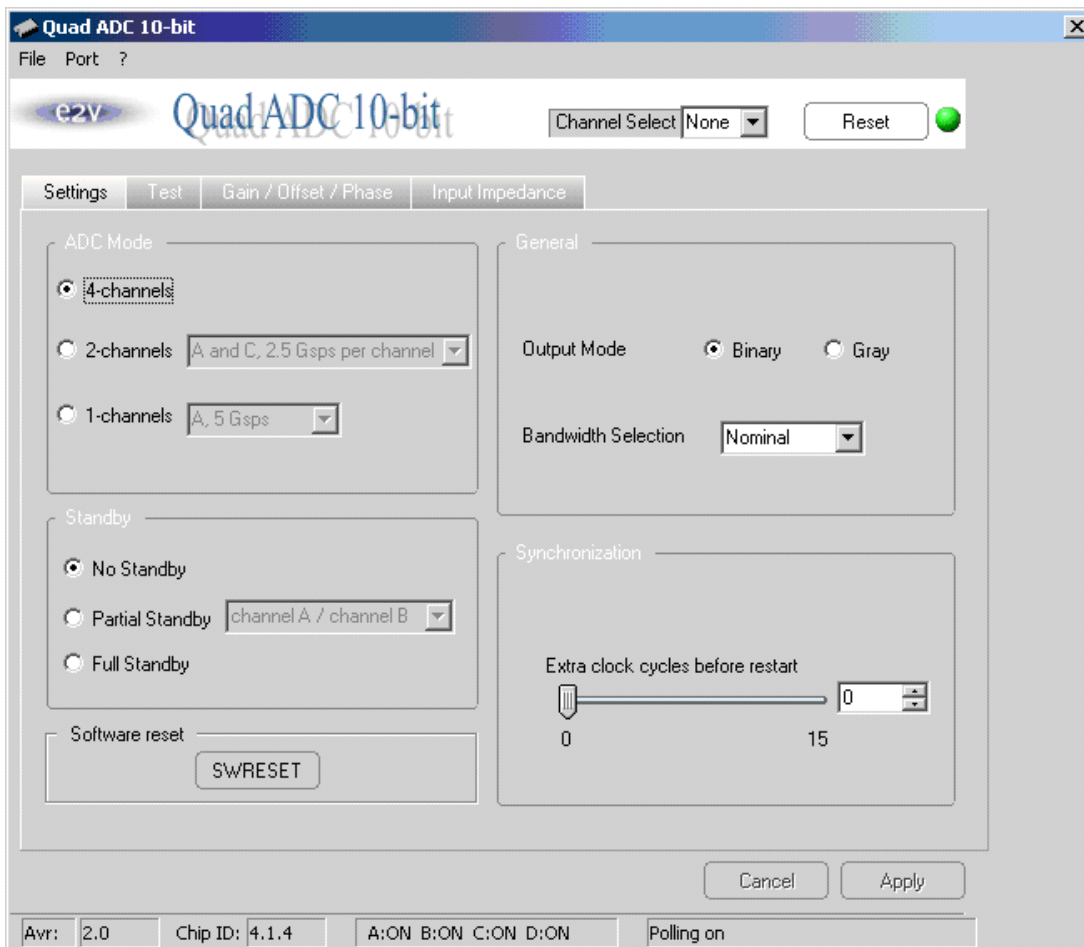

In this window, five functions are available:

■ ADC mode:

- 4-channel mode = the four ADCs work independently at $F_{clock}/2$ sampling rate (where F_{clock} is the external clock signal frequency).

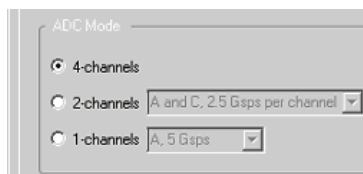

- Two-channel mode = the four ADCs are interleaved two by two (A and B, C and D), the sampling rate is equal to Fclock (where Fclock is the external clock signal frequency), the analog inputs can be applied to A or B and respectively C or D.

Figure 4-15. Two-channel Mode



- One-channel mode = the four ADCs are all interleaved, the sampling rate is Fclock x 2 (where Fclock is the external clock signal frequency), the analog input can be applied to either A, B, C or D channel.

Figure 4-16. One-channel Mode



■ Standby mode

- No standby = all channels are active (A: ON, B: ON, C: ON, D: ON).

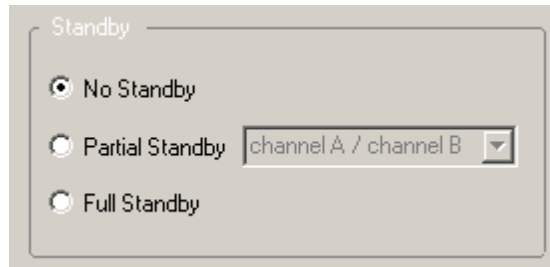

- Partial standby = either A and B are in standby or C and D are in standby.

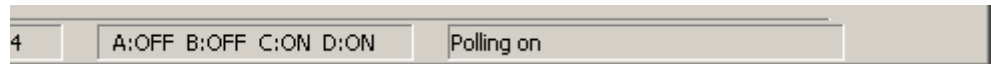
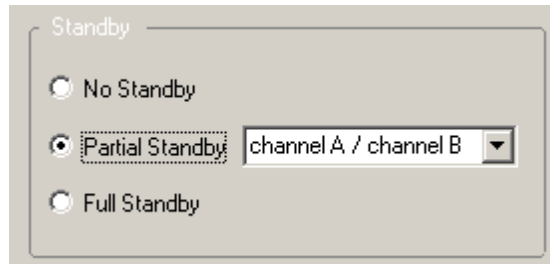

- Full standby = all four ADCs are in standby.

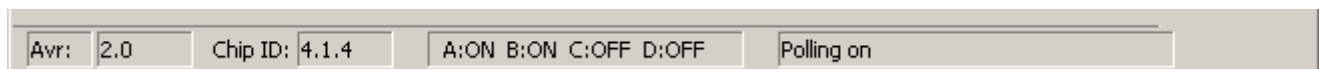
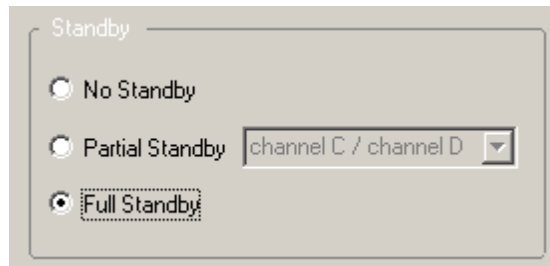

- Full standby = all 4 ADCs are in standby

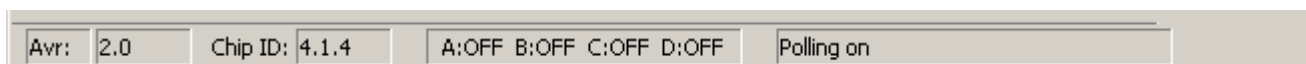
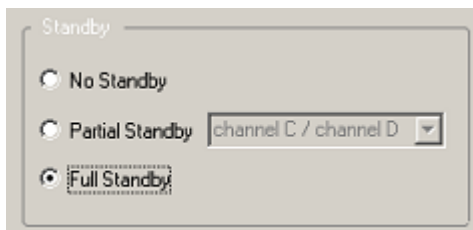

■ General settings

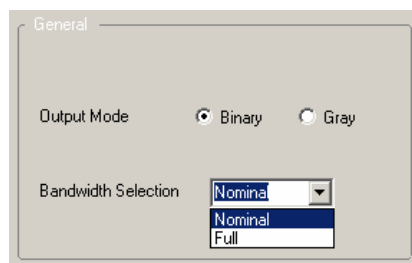

- Output mode = Gray coding or binary coding
- Bandwidth selection = nominal or full band at -3 dB

■ Synchronization: programs the number of clock cycles prior to output clock restart after SYNC reset

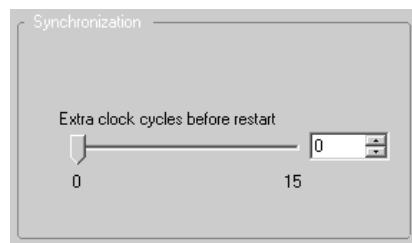

- Software reset = resets the SPI by software

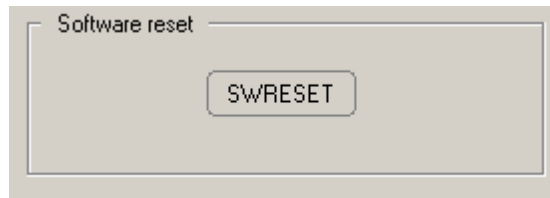

4.6.2 Test

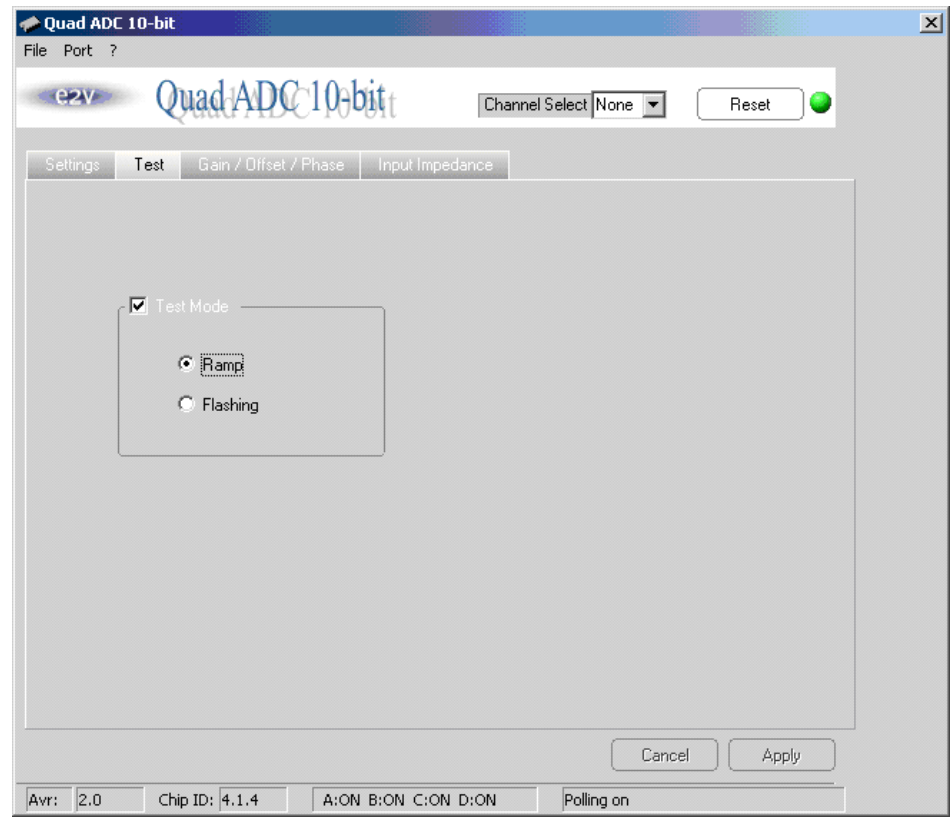

In this window, the test mode is available:

- Either a ramp is generated within each ADC and output
- Or a flashing bit at 1 is output on each ADC (1 FF pattern every ten 00 patterns)

4.6.3 Gain/Offset/Phase

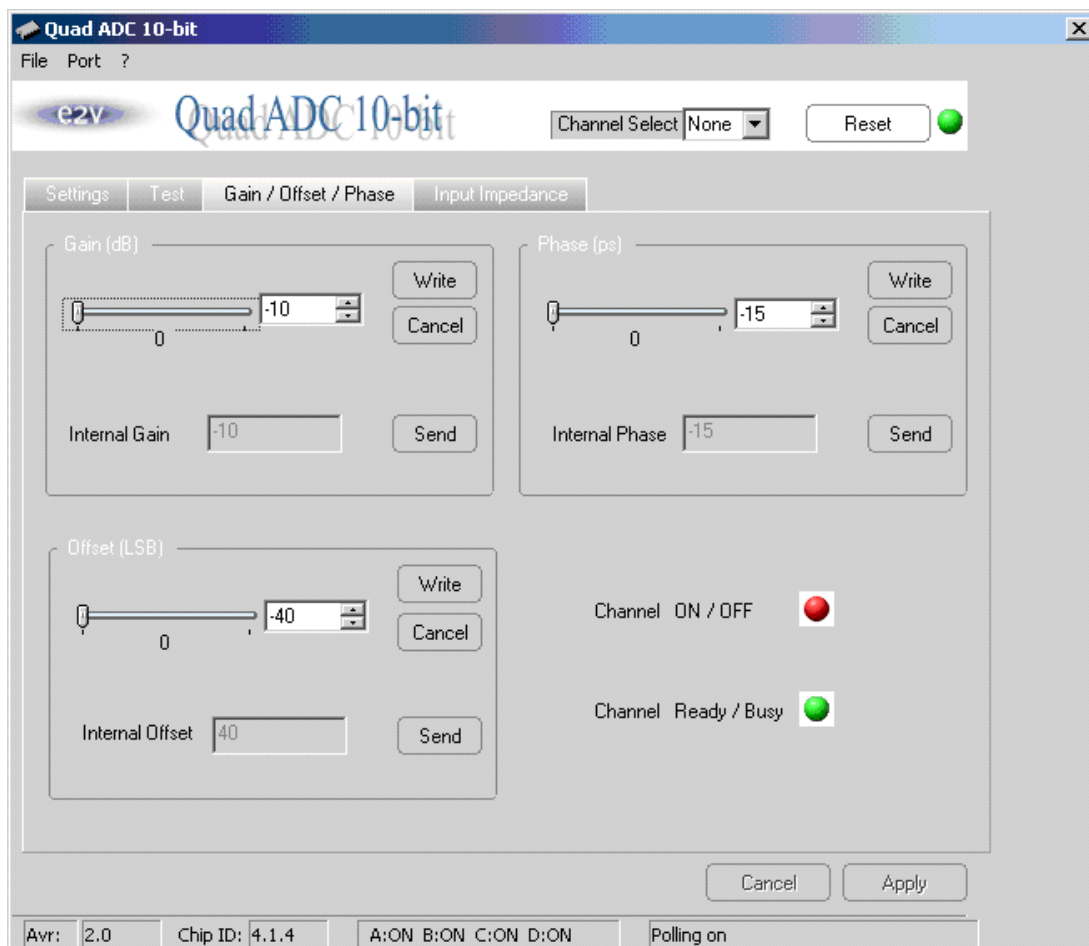

In this window, you can adjust the gain, offset and phase of the channel selected via the *channel select* button on the top right of the user interface.

A LED shows if the channel is ON (active, green LED) or OFF (not active, red LED) and if the same channel is ready (ready to receive gain, offset or phase orders, green LED) or busy (not ready to receive new calibration orders, red LED).

Once a channel has been selected, you can adjust the gain/offset/phase of this channel:

- You first need to enter the desired value for the gain/offset/phase thanks to the cursor.
- If you need to retrieve the old value of the gain/offset/phase click CANCEL.
- Then you should WRITE this value to the internal registers by clicking on the WRITE button.
- If several adjustments are needed (gain AND offset AND phase), then select each value and then click on the respective WRITE buttons.
- Once all adjustments are made via the WRITE buttons, then you can SEND the orders to the ADC SPI via the SEND button.

- The calibration is successful if the internal gain/offset/phase boxes display the entered values.

If a new value for the gain/offset/phase has been entered by mistake, it is possible to retrieve the initial value by pushing the CANCEL button.

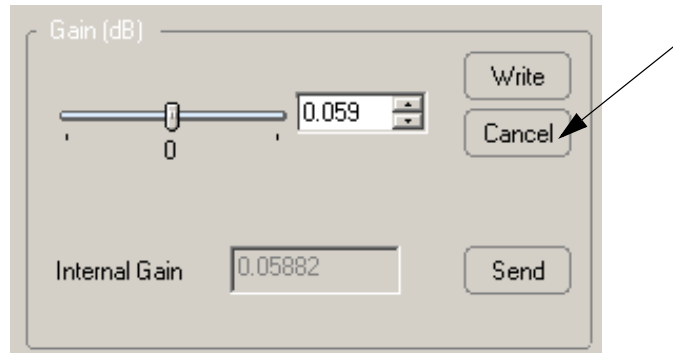

The general *Apply* and *Cancel* general buttons are not active in this window (as soon as the *Send* button is pressed, the gain/offset/phase adjustments are made active).



In the following example, channel A is selected. Values for the gain, the offset and the phase have been entered via the *Write* and then the *Send* buttons, which explains why the Internal values are equal to the settings values.

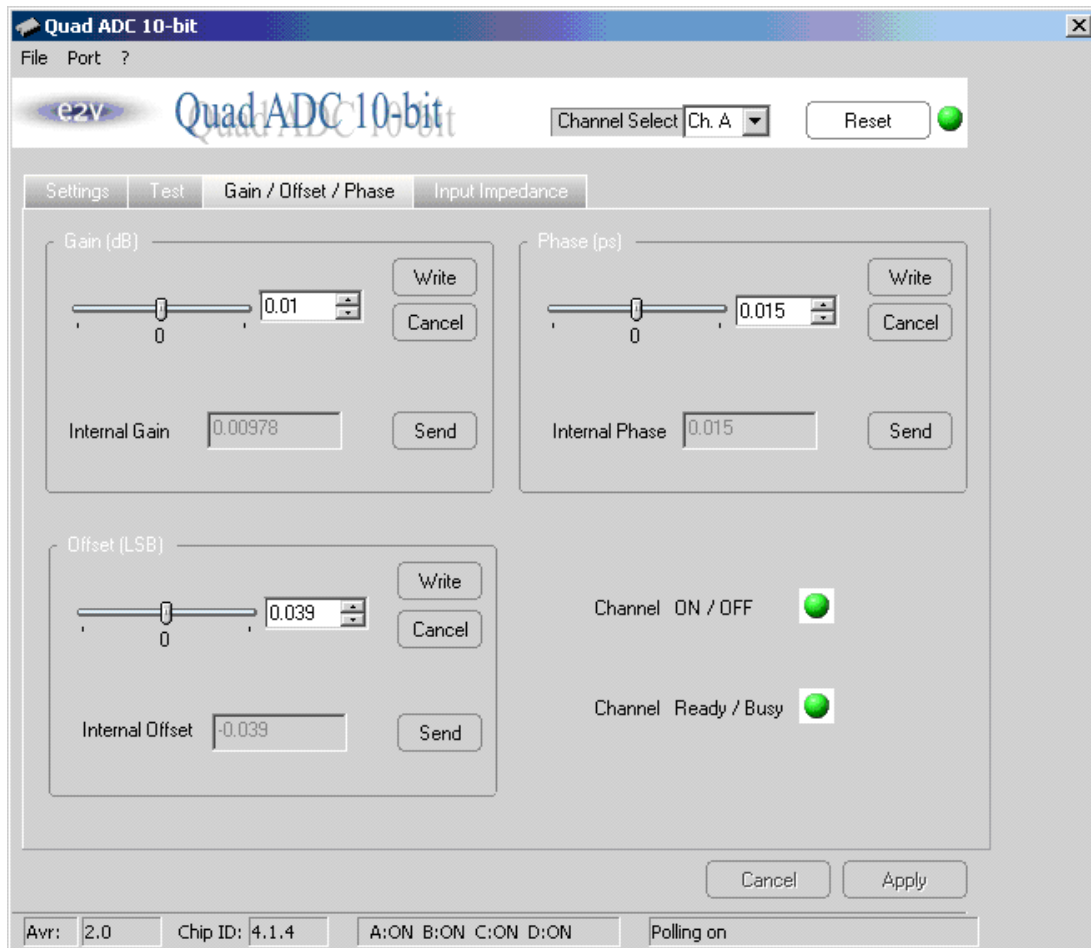

In the following example, you can see that the internal phase register is set to 0.015 and that the user wants the phase to be set to -15 ps. In the second picture, the *Write* and *Send* buttons have been pushed and the internal register shows the new entered value for the phase.

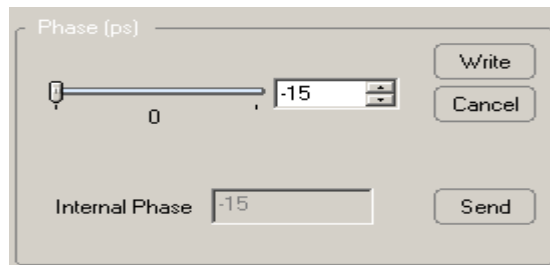
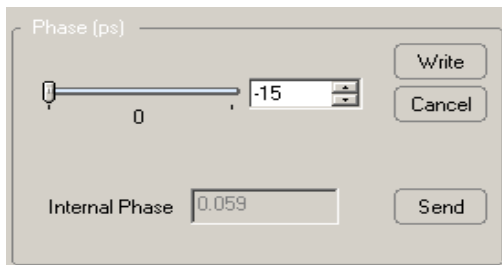

4.6.4 Input Impedance

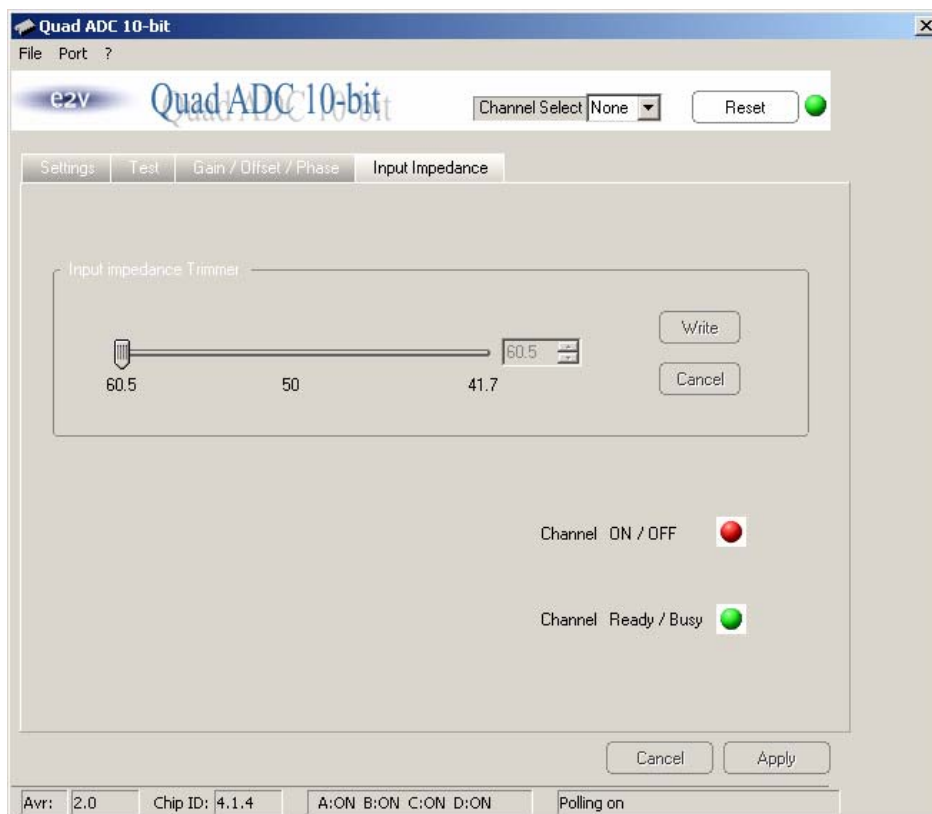

In this window, it is possible to re-adjust the internal input resistor, which should be matched to 50.

The procedure is similar to the previous ones:

- Select the channel where you need to adjust the input impedance
- Check that the channel is ON and *Ready* (green LEDs)
- Enter the resistor value
- Push the *Write* button to write these values to the internal registers (you can retrieve the initial value of the impedance by clicking on the *Cancel* button).

This function helps to re-adjust the input impedance in case of a slight mismatch due to temperature variations or process variations.

4.6.5 Load and Save configuration

The *File* menu shows possibility to load or save a configuration of the EV10AQ190 or to create a data-log file.

It is possible to save the configuration of EV10AQ190 into a .txt file:

Select the *File* menu and click to *Save Configuration*.

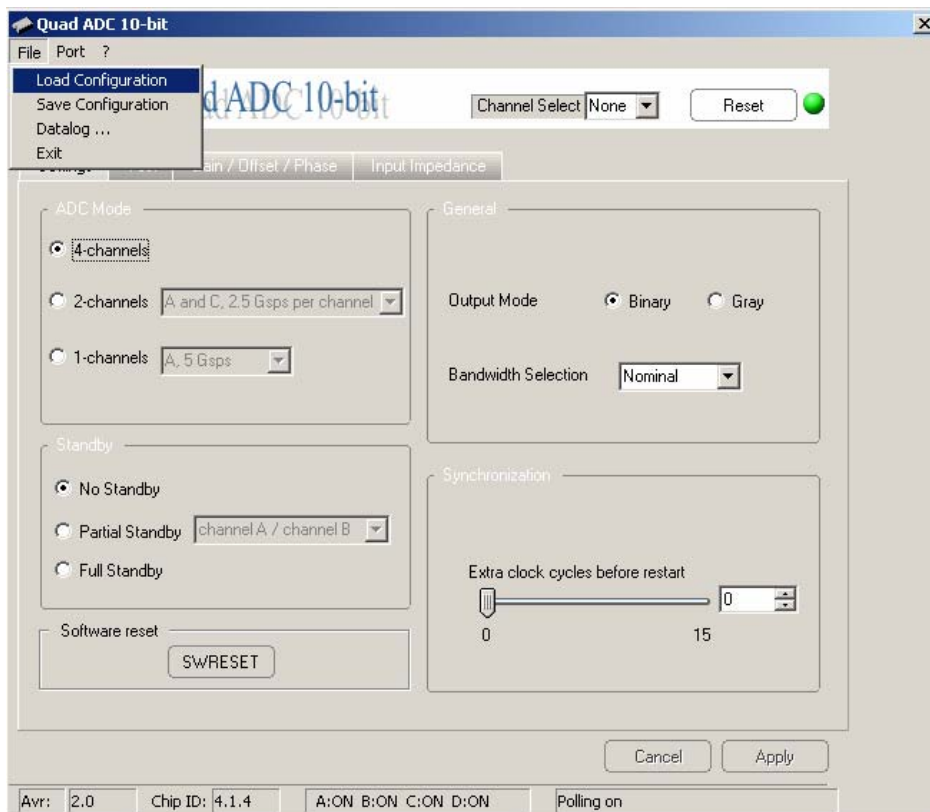

Example of configuration file

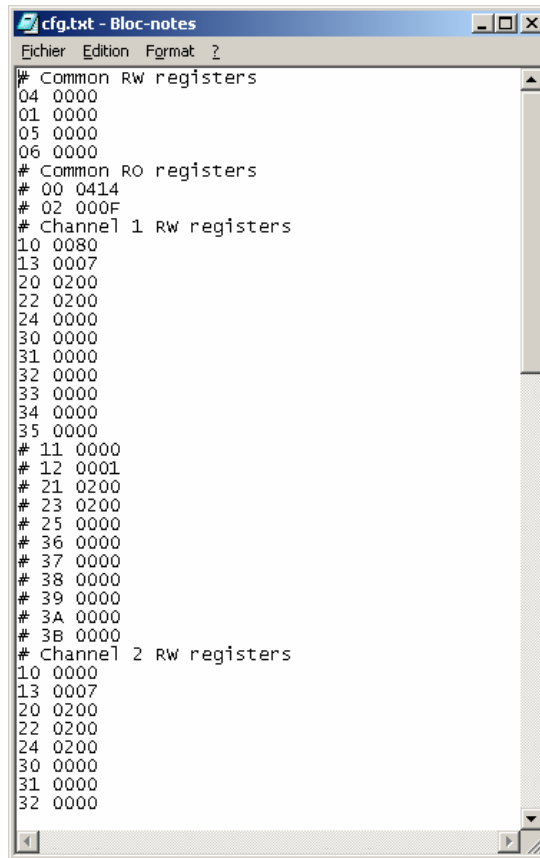

```
cfg.txt - Bloc-notes
Fichier Edition Format ?
# Common Rw registers
04 0000
01 0000
05 0000
06 0000
# Common RO registers
# 00 0414
# 02 000F
# Channel 1 Rw registers
10 0080
13 0007
20 0200
22 0200
24 0000
30 0000
31 0000
32 0000
33 0000
34 0000
35 0000
# 11 0000
# 12 0001
# 21 0200
# 23 0200
# 25 0000
# 36 0000
# 37 0000
# 38 0000
# 39 0000
# 3A 0000
# 3B 0000
# Channel 2 Rw registers
10 0000
13 0007
20 0200
22 0200
24 0200
30 0000
31 0000
32 0000
```

This file could be loaded into the EV10AQ190.

1. Select the *File* menu and click to *Load Configuration* chose the xx.txt file.
2. It is possible to save the Data-log of the EV10AQ190 configuration into a .txt file.
3. Select the *File* menu and click to *Datalog*.

Example of Datalog file:

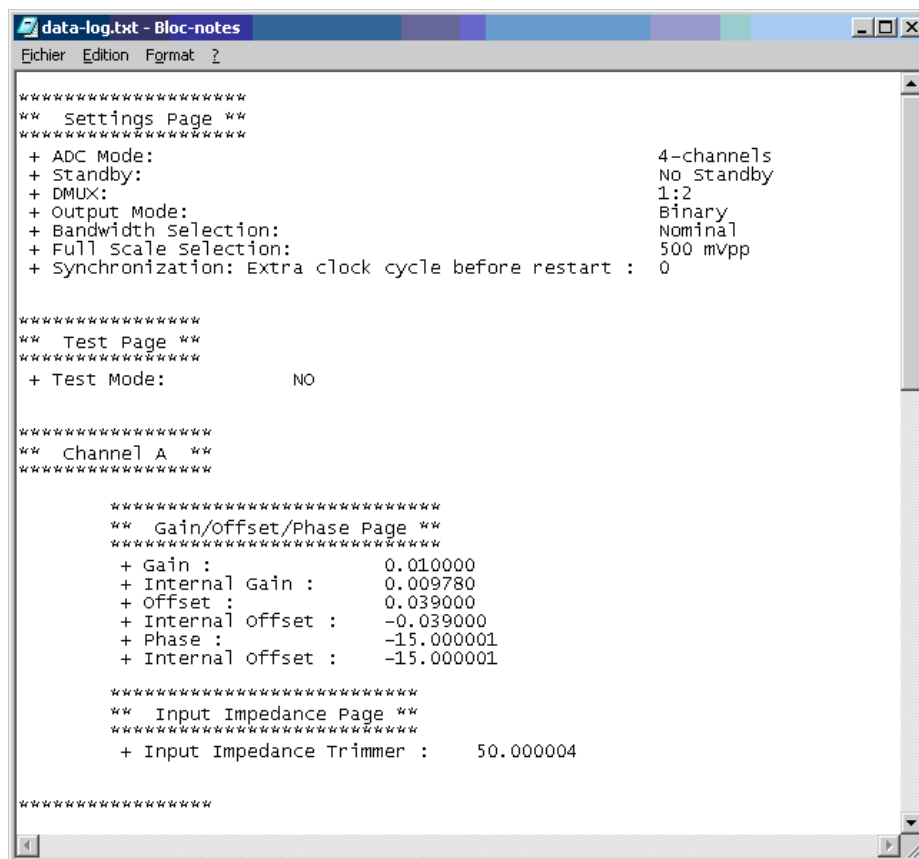

```

data-log.txt - Bloc-notes
Fichier Edition Format ?
*****
** Settings Page **
*****
+ ADC Mode:                4-channels
+ Standby:                 No Standby
+ DMUX:                    1:2
+ Output Mode:             Binary
+ Bandwidth Selection:     Nominal
+ Full Scale Selection:    500 mvpp
+ Synchronization: Extra clock cycle before restart : 0

*****
** Test Page **
*****
+ Test Mode:                NO

*****
** channel A **
*****

*****
** Gain/Offset/Phase Page **
*****
+ Gain :                    0.010000
+ Internal Gain :           0.009780
+ Offset :                  0.039000
+ Internal Offset :        -0.039000
+ Phase :                   -15.000001
+ Internal offset :        -15.000001

*****
** Input Impedance Page **
*****
+ Input Impedance Trimmer : 50.000004

*****

```

Application Information

5.1 Analog Input

The analog input (XAI, XAIN) are entered in differential AC coupled mode as described in Figure 5-1.

It is recommended to use a differential source to drive the analog inputs of this ADC (external balun or differential amplifier).

Note: References of differential amplifiers and external baluns:

- M/A-COM H9 balun
- M/A-COM TP101 1:1 transformer

In order to optimize the performance of the ADC, it is also recommended to use a band pass filter on the analog input path.

Figure 5-1. Differential Analog or Clock Inputs Implementation

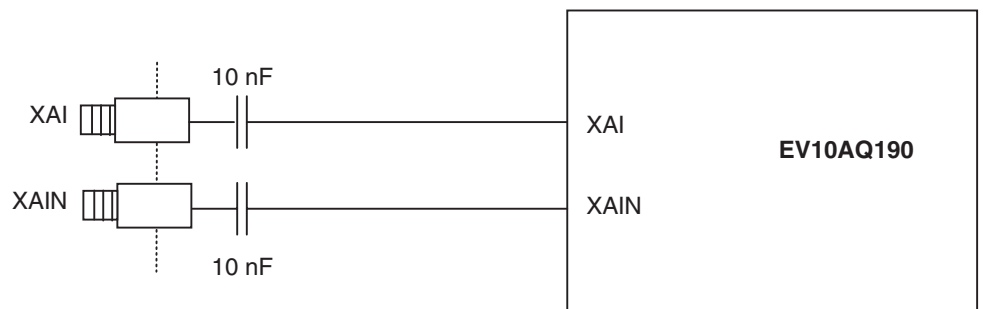

5.2 Clock Input

The clock input can be entered indifferently in single-ended or differential mode with no performance degradation. The clock is AC coupled via 10 nF capacitors as described in Figure 5-2.

Figure 5-2. Clock Input Implementation

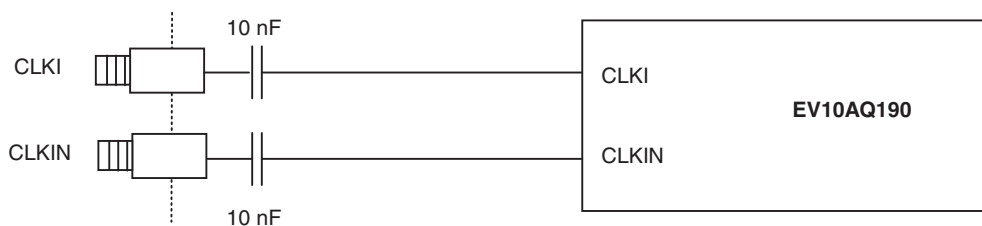

If used in single-ended mode, CLKIN should be terminated to ground via a 50Ω resistor. This is physically done by shorting the SMA on CLKIN with a 50Ω cap.

The jitter performance on the clock is crucial to obtain optimum performance from the ADC. We thus recommend to use a very low phase noise clock and to filter the clock signal if a fixed frequency is used.

For a clock at 500 MHz, we use in our testbench:

- Pass band filter from LORCH MICROWAVE 9BP8-500/30-S (up to 8 dB attenuation, 70 dB rejection up to 5000 MHz)
- 500-14512 500 MHz-SC Sprinter Crystal Oscillator from WENZEL Associates

5.3 Reset input

The SYNCN, SYNCN is necessary to start the ADC after power up.

The reset signal is implemented as illustrated in Figure 5-3.

Figure 5-3. SYNCN, SYNCN Inputs Implementation

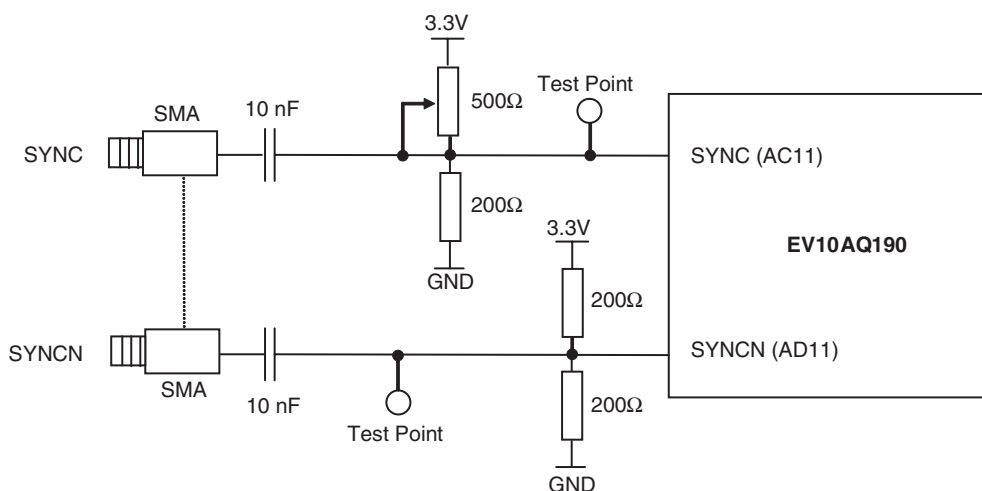

By turning the potentiometer on the SYNC signal to the 3.3V, you activate the reset and de-activate it by turning the potentiometer back to its initial position (near ground).

5.4 Output Data The output data are LVDS and are 100Ω terminated to ground as shown in Figure 5-4.

Figure 5-4. Output Data on-board Implementation

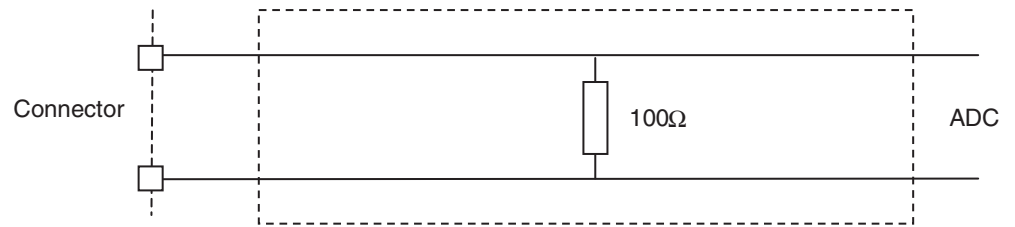

The data are output in binary format and in double data rate (the output clock frequency is half the data rate and thus half the input clock frequency).

5.5 CMIRefAB and CMIRefCD Output Signals Two 2 mm banana jacks are provided for the CMIRefAB and CMIRefCD signals which provides the analog input common mode voltages (= 1.6V). As the analog input is entered in AC coupled mode, these CMIRefAB and CMIRefCD signals do not need to be used.

5.6 Diode for Junction Temperature Monitoring Two 2 mm banana jacks are provided for the die junction temperature monitoring of the ADC. One banana jack is labeled DIODA and should be applied a current of up to 1 mA (via a multimeter used in current source mode) and the second one is connected to DIODC. The ADC diode is protected via 2 x 3 head-to-tail diodes. Figure 5-5 describes the setup for the die junction temperature monitoring using a multimeter.

Figure 5-5. Die Temperature Monitoring Test Setup

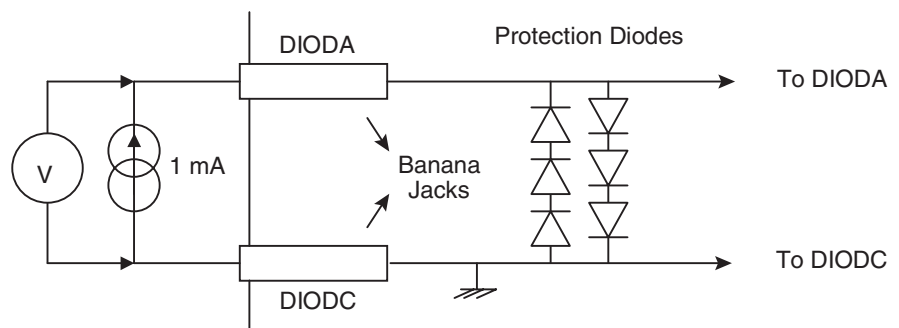

5.7 Test Bench Description

Figure 5-6. Test Bench Description

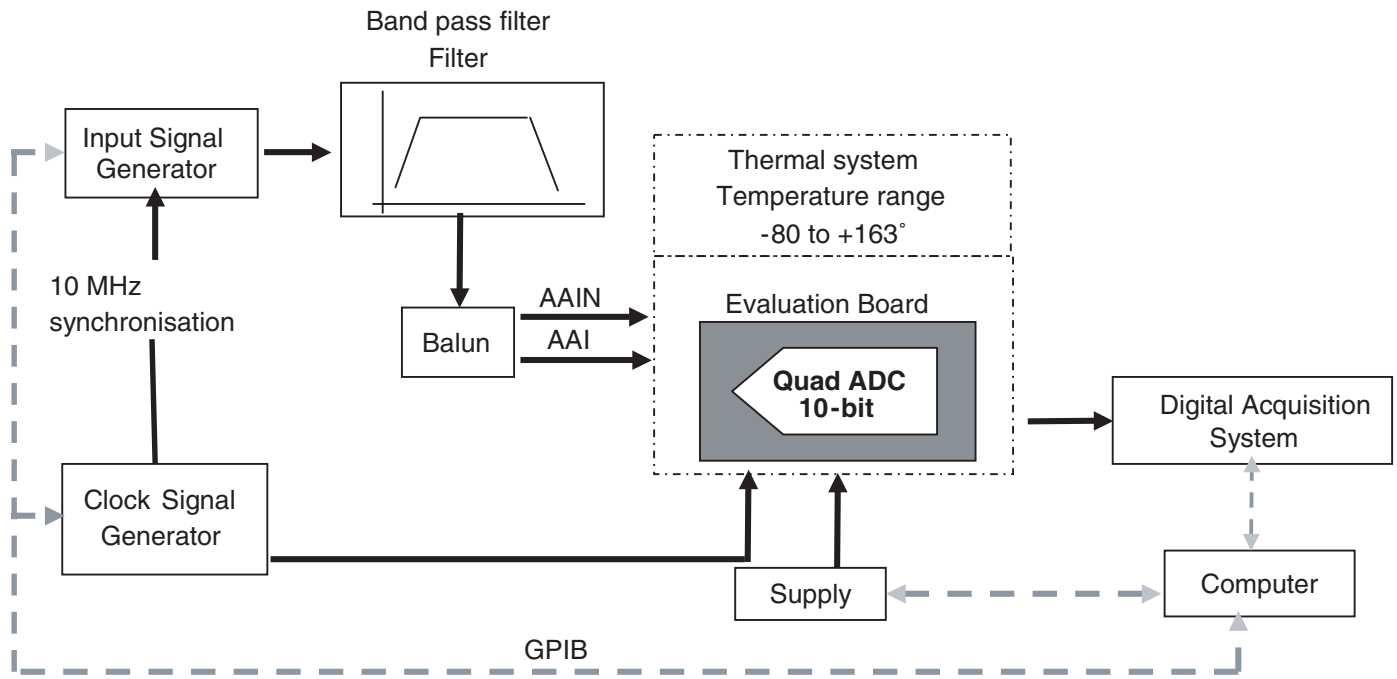

Ordering Information

6.1 Ordering Information

Table 6-1. Ordering Information

Part Number	Package	Temperature Range	Screening Level	Comments
EV10AQ190CTPY	EBGA 380 RoHS	Ambient	Standard	
EV10AQ190TPY-EB	EBGA 380 RoHS	Ambient	Prototype	Evaluation board

7.1 EV10AQ190-EB Electrical Schematics

Figure 7-1. Power Supplies Bypassing

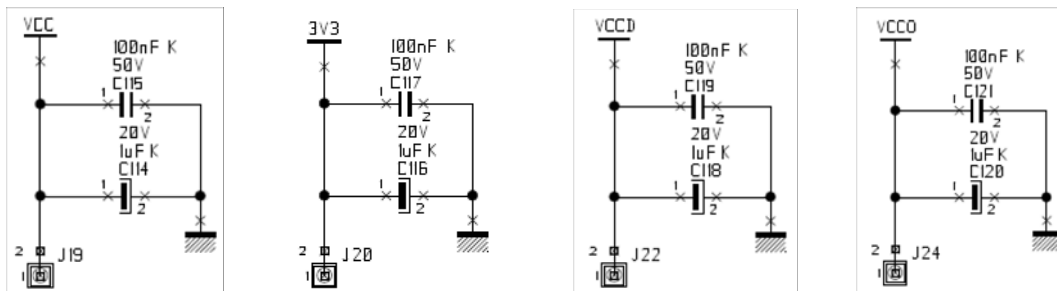

Figure 7-2. Power Supplies Decoupling (J = ± 5% Tolerance)

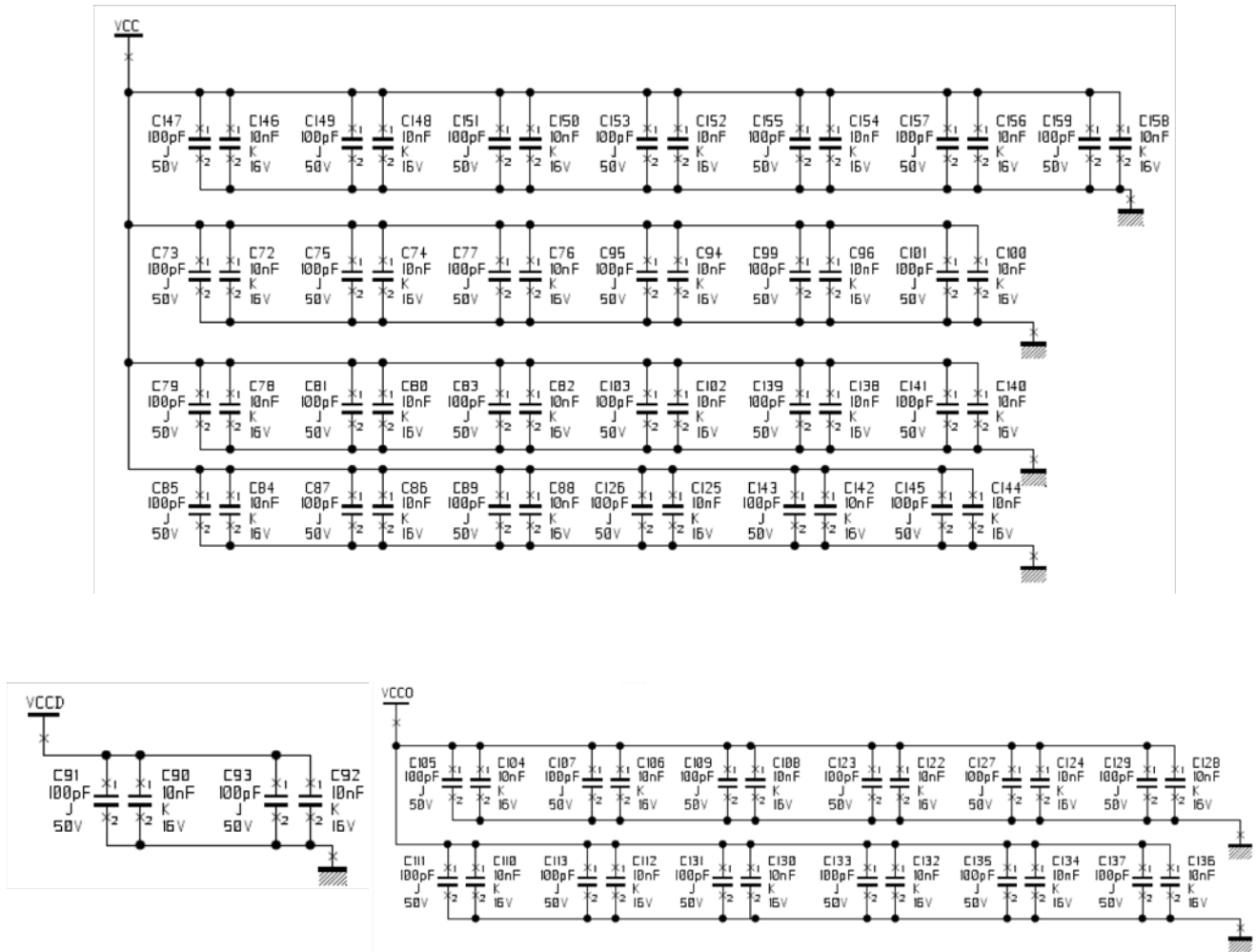

Figure 7-3. Electrical Schematics (AVR)

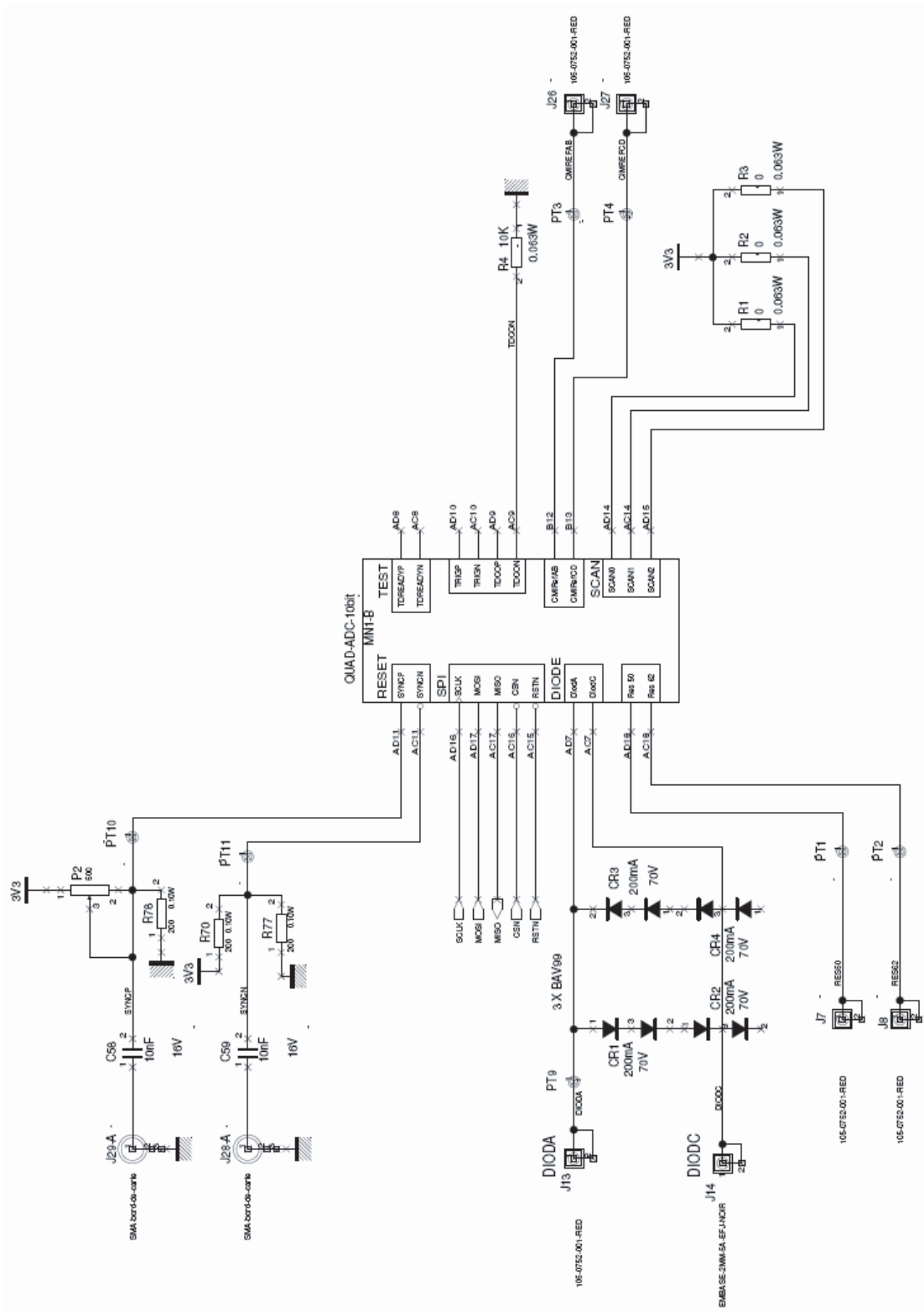

Figure 7-4. Electrical Schematics (ADC)

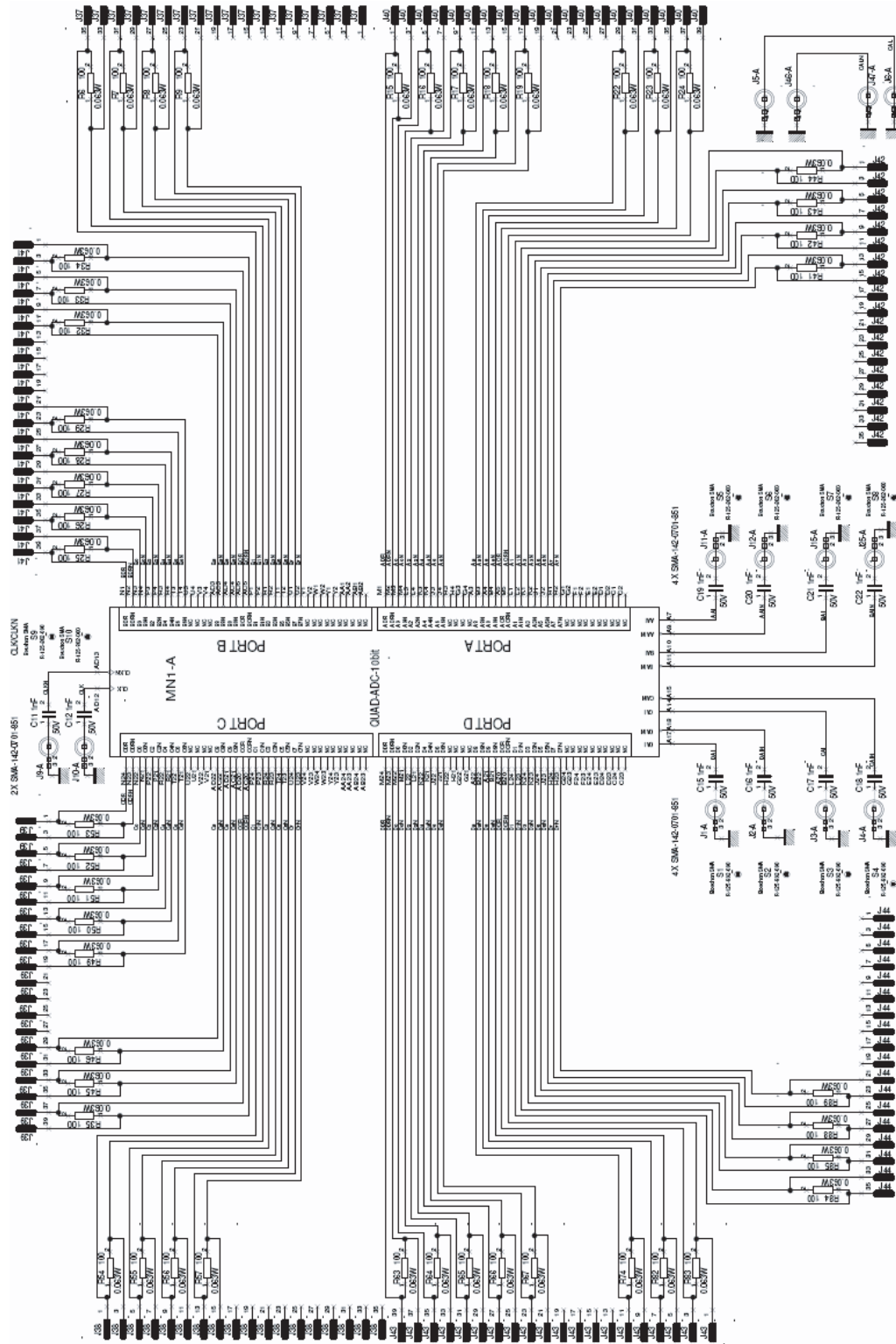

Figure 7-6. Bottom Layer

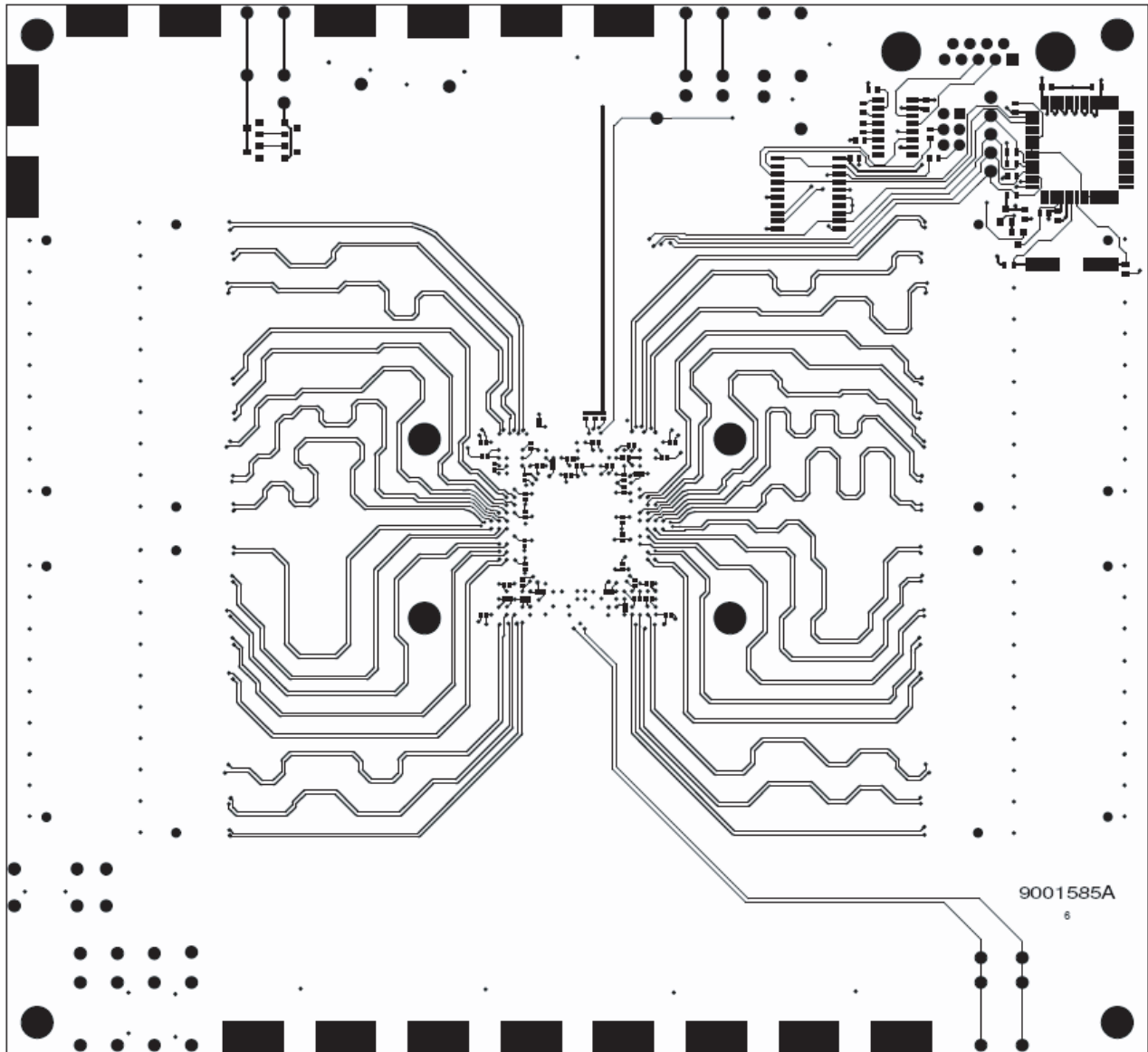

Figure 7-7. Equipped Board (Top)

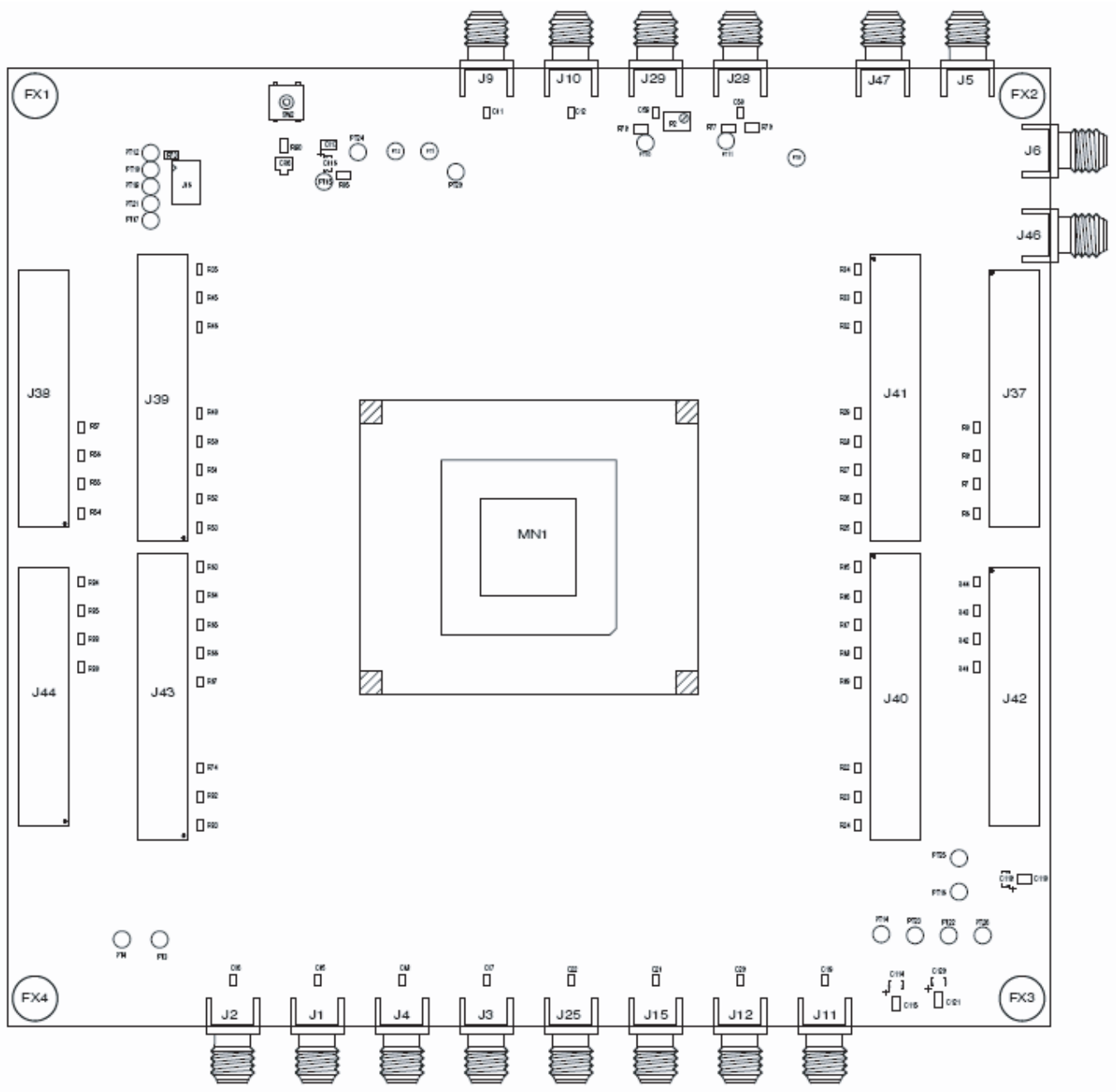
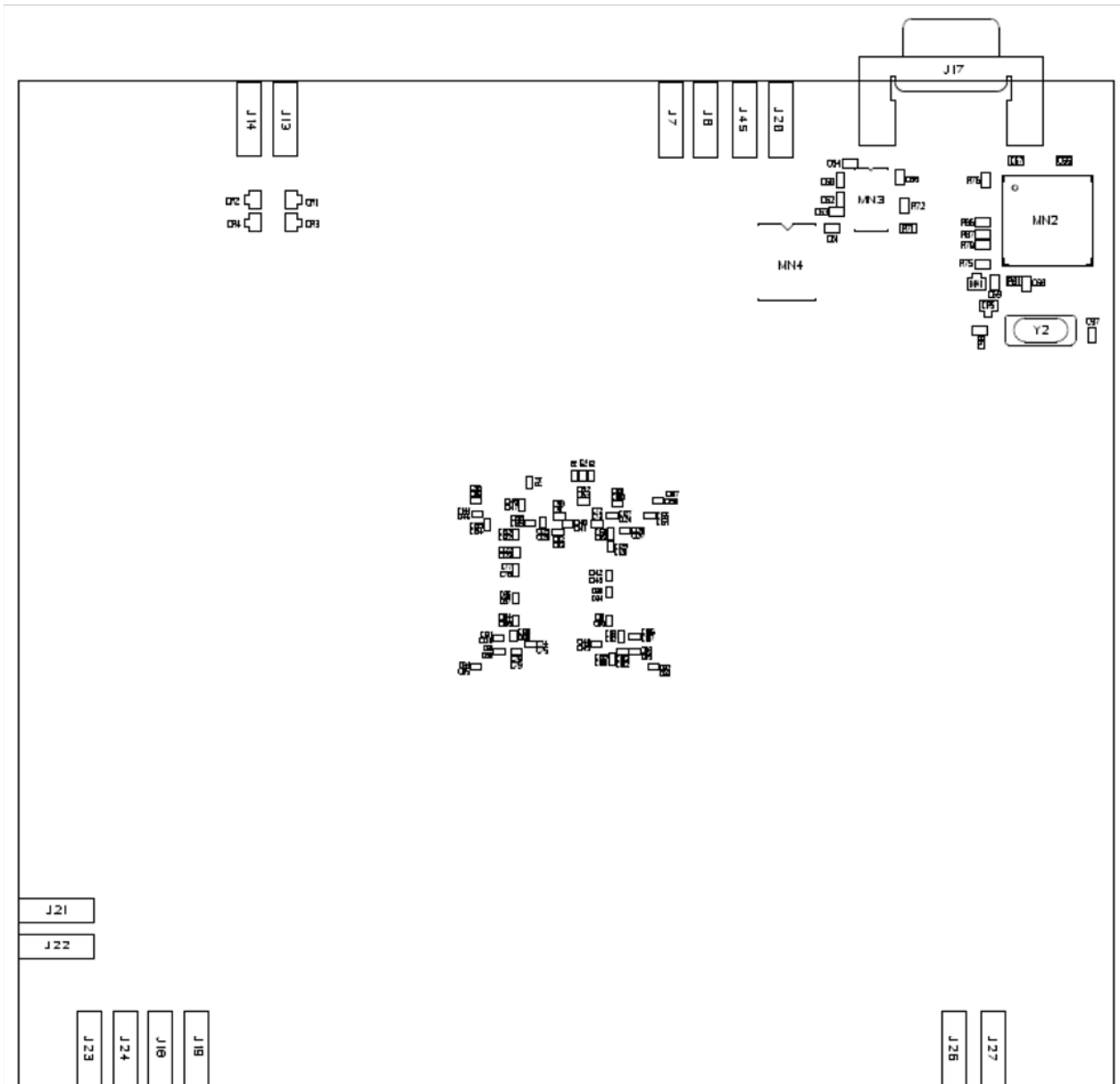

Figure 7-8. Equipped Board (Bottom)



Section 1

1.1	Scope	1-3
1.2	Description	1-3

Section 2

2.1	Board Structure	2-5
2.2	Analog Inputs/Clock Input	2-6
2.3	Digital Output	2-6
2.4	Reset Inputs	2-7
2.5	Power Supplies	2-9

Section 3

3.1	Introduction	3-11
3.2	Operating Procedure	3-11
3.3	Electrical Characteristics	3-12

Section 4

4.1	Overview	4-15
4.2	Configuration	4-15
4.3	Getting Started	4-16
4.4	Troubleshooting	4-21
4.5	Installation Software	4-22
4.6	Operating Modes	4-23
4.6.1	Settings	4-24
4.6.2	Test	4-28
4.6.3	Gain/Offset/Phase	4-29
4.6.4	Input Impedance	4-32
4.6.5	Load and Save configuration	4-33

Section 5

5.1	Analog Input	5-37
5.2	Clock Input	5-38
5.3	Reset input	5-38
5.4	Output Data	5-39
5.5	CMIRefAB and CMIRefCD Output Signals	5-39
5.6	Diode for Junction Temperature Monitoring	5-39
5.7	Test Bench Description	5-40

Section 6

6.1	Ordering Information	6-41
-----	----------------------------	------

Section 7

7.1	EV10AQ190-EB Electrical Schematics.....	7-43
7.2	EV10AQ190-EB Board Layers.....	7-47



How to reach us

Home page: www.e2v.com

Sales offices:

Europe Regional sales office

e2v ltd

106 Waterhouse Lane
Chelmsford
Essex CM1 2QU
England
Tel: +44 (0)1245 493493
Fax: +44 (0)1245 492492
mailto: enquiries@e2v.com

Europe Regional sales office

e2v sas

16 Burospace
F-91572 Bièvres
Cedex
France
Tel: +33 (0) 16019 5500
Fax: +33 (0) 16019 5529
mailto: enquiries-fr@e2v.com

Europe Regional sales office

e2v gmbh

Industriestraße 29
82194 Gröbenzell
Germany
Tel: +49 (0) 8142 41057-0
Fax: +49 (0) 8142 284547
mailto: enquiries-de@e2v.com

Americas

e2v inc

4 Westchester Plaza
Elmsford
NY 10523-1482
USA
Tel: +1 (914) 592 6050 or
1-800-342-5338,
Fax: +1 (914) 592-5148
mailto: enquiries-na@e2v.com

Asia Pacific

e2v ltd

11/F.,
Onfem Tower,
29 Wyndham Street, Central,
Hong Kong
Tel: +852 3679 364 8/9
Fax: +852 3583 1084
mailto: enquiries-ap@e2v.com

Product Contact:

e2v

Avenue de Rochepleine
BP 123 - 38521 Saint-Egrève Cedex
France
Tel: +33 (0)4 76 58 30 00

Hotline:

mailto: hotline-bdc@e2v.com

Whilst e2v has taken care to ensure the accuracy of the information contained herein it accepts no responsibility for the consequences of any use thereof and also reserves the right to change the specification of goods without notice. e2v accepts no liability beyond that set out in its standard conditions of sale in respect of infringement of third party patents arising from the use of tubes or other devices in accordance with information contained herein.

